

BERTOCCI

Bathroom Accessories

FIRENZE 1929

90 anni di storia
lasciano tracce
indelebili.

90 years of
history leave
indelible traces.

BERTOCCI
Bathroom Accessories

INTRODUZIONE

Quella del marchio Bertocci è una storia tutta italiana di artigianalità, originalità e innovazione.

Casa fondata nel 1929 da Arnolfo Bertocci, l'azienda avvia la produzione di cerniere per ferramenta e solo alcuni anni dopo si aggiungono alla gamma gli accessori da bagno, divenuti negli anni '40 articoli indispensabili per l'ambiente bagno.

Quest'ampliamento di gamma adduce all'azienda la svolta che in pochi anni la proietta nel mondo intero come pioniere prima e leader poi, nel settore dei complementi di arredo bagno.

Sono le molte collaborazioni fortunate della divisione progettazione interna aziendale con architetti ed ingegneri prima e designers più recentemente che hanno consolidato per decenni la posizione dell'azienda tra i produttori più rinomati del comparto in Italia e nel mondo.

Nel 2014 si è aperto un nuovo capitolo della storia aziendale con l'acquisizione da parte di un giovane imprenditore fiorentino che con la propria famiglia ha voluto dare continuità all'attività aziendale.

Nel massimo rispetto dei disegni originali Bertocci Arnolfo e degli elevati standard produttivi di cui l'azienda si è sempre fregiata, oggi come ieri Bertocci Industrie è dedita all'innovazione del comparto accessori bagno tant'è che già nel 2016, ad appena due anni dalla sua nascita, viene insignita dell'ADI Design Award per la sua nuova serie Fly, frutto anch'essa della collaborazione tra la divisione design e progettazione interna Bertocci e dei Designers Meneghello e Paoletti, già ideatori per Bertocci di serie molto apprezzate come Freeze.

Ancora oggi i prodotti Bertocci vengono interamente prodotti in Toscana con i più pregiati materiali e grazie alla sapienza ed esperienza delle più alte maestrie del comparto.

Passione, dovizia ed ambizione sono le pulsioni che muovono l'azienda verso una continua innovazione tecnico-costruttiva dei propri prodotti.

Dal 1929 ed oggi sempre più l'azienda investe in ricerca, design, innovazione e funzionalità salvaguardando al contempo competenza artigianale e ottimizzazione produttiva, privilegiando altissimi standard qualitativi e servizio al cliente.

INTRODUCTION

That of the Bertocci brand is an all-Italian story of craftsmanship, originality and innovation.

Founded in 1929 by Arnolfo Bertocci, the company started production of hardware hinges and only a few years later the bathroom accessories were added to the range, which in the 1940s became indispensable articles for the bathroom. This extension of the range gives the company the turning point that in a few years projects it throughout the world as a pioneer and then leader in the bathroom accessories sector.

These are the many successful collaborations of the company's internal design division with architects and engineers first and more recently designers who have consolidated for decades the position of the company among the most renowned producers in the sector in Italy and in the world.

In 2014 a new chapter of company history was opened with the acquisition by a young Florentine entrepreneur who with his own family wanted to give continuity to the business activity.

In the utmost respect for the original Bertocci Arnolfo designs and the high production standards that the company has always boasted, today as yesterday Bertocci Industrie is dedicated to the innovation of the bathroom accessories sector so much so that already in 2016, just two years from his birth, he was awarded the ADI Design Award for his new Fly series, also the result of the collaboration between the design division and internal design Bertocci and Designers Meneghello and Paoletti, already creators for Bertocci series much appreciated as Freeze.

Even today the Bertocci products are entirely produced in Tuscany with the finest materials and thanks to the knowledge and experience of the highest mastery of the sector.

Passion, abundance and ambition are the drives that move the company towards a continuous technical-constructive innovation of its products.

Since 1929 and nowadays more and more the company has invested in research, design, innovation and functionality, while safeguarding craftsmanship and production optimization, favoring the highest quality standards and customer service.

1929

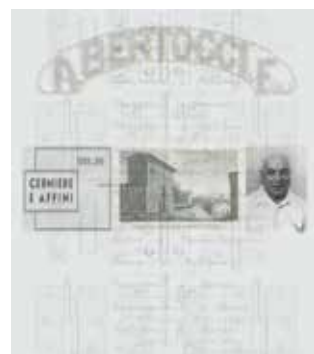

Nel 1929 Arnolfo Bertocci inizia la sua attività di produzione di cerniere in metallo nell' officina di Porta San Frediano, in uno dei più antichi quartieri di Firenze.

In 1929 Arnolfo Bertocci began his activity of production of metal hinges in the workshop of Porta San Frediano, in one of the most ancient districts of Florence.

1994

Nel maggio 94 nasce la serie Cinquecento, una collezione ampia e articolata, che, ha toccato records di consenso e di vendite nella storia dell'azienda che, oramai leader indiscussa in Italia,

In May 94 the Cinquecento series was born, a wide and complex collection, which touched consensus and sales records in the company's history, which is now undisputed leader in Italy.



1960



Dall'inizio degli anni '60 le collezioni si rinnovano e la gamma dei prodotti si amplia.

Since the beginning of the 1960s, the collections have been renewed and the range of products has expanded.

1950



Gli anni '50 segnano la nascita, con la serie Giglio, della prima collezione di accessori in ottone cromato per la stanza da bagno.

The '50s mark the birth, with the Giglio series, of the first collection of accessories in chromed brass for the bathroom

2004



Il catalogo si arricchisce delle prime collezioni integrate, che aprono all'arredo del bagno e della casa. Giancarlo Vegni crea Gill, un sistema integrato.

The catalog is enriched by the first integrated collections, which open to the bathroom and home furnishings, Gill is an integrated system.

1970



Gli anni '70 erompono in tutta la loro potenza. Per l'azienda rappresentano il momento del consolidamento e della maturità.

The 70s erupt in all their power. For the company they represent the moment of consolidation and maturity.

2009



Nel 2007 Grimilde di Stefano Bertocci e Geraldine Naldini segna un evento glamour in catalogo.

In 2007 Grimilde by Stefano Bertocci and Geraldine Naldini marks a glamorous event in the catalog.

2007



Nasce on Line, che unisce rigore stilistico e massima libertà espressiva.

It was born on Line, which unifies stylistic rigor and maximum freedom of expression.

1980



E' un momento di grande creatività e nuovi prodotti. Corrimano e Segno, nati alla fine del decennio precedente, esprimono negli anni 80 tutto il loro potenziale.

It is a moment of great creativity and new products. Corrimano e Segno, born at the end of the previous decade, express their full potential in the 1980s.

2016

ADI
CERAMIC
DESIGN
AWARD

2016

Presentata in anteprima assoluta al Cersaie 2016, la nuova linea Fly disegnata da Meneghello e Paolelli Associati, vincitrice del "ADI CERAMIC DESIGN AWARD 2016"



The new Fly line designed by Meneghello and Paolelli Associati was presented in absolute preview at Cersaie 2016, winner of the "ADI CERAMIC DESIGN AWARD 2016"

continua.....

I designer che negli anni hanno fatto la nostra storia.

The designers who have done our history through years.

BERTOCCI

Bathroom Accessories



LUCA BOJOLA

Studio Luca Bojola è un'azienda di design e interior design che lavora sia nel design contemporaneo che classico. Con quasi trent'anni di esperienza nella collaborazione con artigiani d'élite, Luca Bojola collabora con le case di produzione per creare oggetti e creare spazi che siano senza tempo bellissimi. Luca Bojola disegna anche pezzi unici realizzati con materiali preziosi e semi-preziosi.

Seguendo il flusso degli eventi, per il fiorentino Luca Bojola, design, artigianato e materiale hanno sempre viaggiato mano nella mano. Per quasi 30 anni, Bojola ha creato oggetti e spazi modellati che

trascendono i confini, lavorando con gli opposti e sfruttando la tensione creativa che esiste quando gli stili classici e contemporanei si incontrano. Ognuna delle creazioni di Bojola è allo stesso tempo audace e sottile, senza tempo classica e moderna. Ha lavorato con tutti i materiali tradizionali, dalle sue prime esplorazioni con la ceramica, il vetro, il metallo, il bronzo e il marmo alla sua opera più recente con materiali semi-preziosi. Il percorso creativo di Bojola è stato non convenzionale e iconoclasta. Atleta d'élite al liceo in gara per la squadra nazionale di canottaggio, Bojola si iscrisse successivamente alla facoltà di medicina dell'Università di Firenze. Quattro anni dopo lasciò la medicina e si avventurò nel mondo dell'artigianato e della produzione per lavorare a Murano con il maestro vetraio Moretti. Successivamente ha lanciato una linea di accessori decorativi autoprodotti. Avido velista fin dall'infanzia, nel 1978 Bojola si trasferì a St. Croix, nelle Isole Vergini americane, per unire il suo amore per l'acqua con il suo desiderio di creare oggetti assumendo il ruolo di direttore artistico per Artistic Ceramic Corporation, un laboratorio di creazione di regali. Tornato a Firenze nel 1983, Bojola ha aperto lo studio Luca Bojola in un fienile ricavato nella bellissima campagna a sud di Firenze.

Firma per Bertocci le serie ES, LEGER

Studio Luca Bojola is a design and interior architecture company working in both contemporary and classic design. With almost three decades of experience collaborating with elite craftsmen, Luca Bojola partners with production companies to create objects and shape spaces that are timelessly beautiful. Luca Bojola also designs one-of-a-kind pieces crafted from precious and semi-precious materials. Following the flow of events, for Florentine-born Luca Bojola, design, craft and material have always traveled hand-in-hand. For almost 30 years, Bojola has created objects and shaped spaces that transcend boundaries, working with opposites and exploiting the creative tension that exists when classic and contemporary styles meet. Each one of Bojola's creations is at once bold and subtle, timelessly classical and refreshingly modern. He has worked with all the traditional materials, from his early explorations in ceramic, glass, metal, bronze and marble to his more recent work with semi-precious materials. Bojola's creative path has been unconventional and iconoclastic. An elite athlete in high school competing for the Italian national rowing team, Bojola enrolled in medical school at the University of Florence. Four years later, he left medicine and ventured into the world of craft and production to work with master glassblower Moretti in Murano, Venice. He then launched a self-produced line of decorative accessories. An avid sailor since childhood, in 1978 Bojola moved to St. Croix, U.S. Virgin Islands, to combine his love of water with his desire to create objects by taking on the role of artistic director for Artistic Ceramic Corporation, a gift-making workshop. Upon returning to Florence in 1983, Bojola opened Studio Luca Bojola in a converted barn located in the beautiful countryside minutes south of Florence.



MENEGHELLO & PAOLELLI

Sandro Meneghello e Marco Paoletti, entrambi classe 1979, si sono laureati con lode al Politecnico di Milano, Facoltà del Design, nel 2004, sotto la guida di Roberto Palomba e Paolo Rizzatto.

Si riuniscono dopo diverse esperienze internazionali: dalla Central Saint Martins College di Londra e la Norwegian University of Science & Technology

di Trondheim, alla Köln Kisd University e EDF R&B a Parigi, prima di iniziare il loro studio a Milano. Dal 2010 collaborano con Bertocci e nel 2016 con la serie FLY vincono IL DESIGN AWARD 2016.

Dal 2005 collaborano con aziende italiane ed estere, tra cui Antonio Lupi, Fiam, Horm, Unopiù, Twils, Artceram, Porcellanosa, Glass 1989 Idromassaggio, Victoria + Albert, Ridea, Bertocci, Fima Carlo Frattini, Hidra, Grantour, Kreaty. La loro attività spazia dalla progettazione del prodotto alla sua comunicazione, con l'obiettivo di coordinare tutti gli strumenti che le aziende dispongono per comunicare in maniera univoca la loro identità. I loro prodotti sono stati esposti in tutto il mondo ed hanno ricevuto vari riconoscimenti internazionali, tra cui 5 Red Dot Design Awards, 5 Design Plus, 2 Good Design Awards, un ADI Design Index, una menzione speciale per il German Design Award e sei menzioni allo Young&Design.

Sandro Meneghello and Marco Paoletti, both born in 1979, graduated at the Politecnico di Milano, Faculty of Design, in 2004, under the guidance of Roberto Palomba and Paolo Rizzatto. They separately gather different international experiences: from Central Saint Martins College in London and Norwegian University of Science&Technology in Trondheim to Köln Kisd University and EDF R&B in Paris, before starting their studio in Milan. Since 2010 they have collaborated with Bertocci and in 2016 they have won the Design Award 2016 with the collection FLY. Since 2005 they have collaborated with several Italian and foreign companies, including Antonio Lupi, Fiam, Horm, Unopiù, Twils, Artceram, Porcellanosa, Glass 1989 Idromassaggio, Victoria + Albert, Ridea, Bertocci, Fima Carlo Frattini, Hidra, Grantour, Kreaty and more. During their collaboration, they have received several international recognitions, including five Red Dot Design Awards, five Design Plus, two Good Design Awards, one ADI Design Index, a special mention for the German Design Award and six mentions to the Young&Design.



PHICUBO

Alessandra Bertini architetto e Gianluca Belli designer, nel 2006 fondano lo studio Phicubo Design.

I loro progetti cercano di rendere prodotto le proprie convinzioni etiche progettuali: funzionalità, unicità, valore sociale, innovazione. Dal 2006 collaborano con varie aziende, italiane e non, come Treemme rubinetterie, Bertocci oltre che con Università e studi di ricerca fra cui Packlab - Università degli Studi di Milano e con l'Università di Architettura di

Firenze per il corso di Arredamento e architetture degli interni. Phicubo ha ricevuto numerosi premi per l'alta qualità nel rapporto tra design ed ecologia; nel 2007 è stata riconosciuta come una tra le 60 aziende ecoefficienti del territorio Toscano con il Premio Vespucci, ha vinto il design Plus Award di Francoforte nel 2012 per il design innovativo della doccia Philo, e numerose altre menzioni per la l'applicazione dei principi dell'Universal Design. La serie di PIANTANE MOON, disegnata per Bertocci Industrie nel 2016, è esilarante, fresca, minimale e simpatica ma allo stesso tempo funzionale: ecco il mood della nuova collezione nata dalla collaborazione fra i due designer e architetti Gianluca Belli e Alessandra Bertini con Bertocci. Il progetto ha l'ambizione di modificare e plasmare il vecchio concetto solo tecnico delle piantane di servizio ormai statico e obsoleto. L'ispirazione nata dal mondo dell'arredamento ha creato la prima collezione di accessori da appoggio direttamente sul pavimento.

Alessandra Bertini, architect, and Gianluca Belli, designer, founded the Phicubo Design studio in 2006. Their projects try to make « product » their own ethical design perspectives: functionality, uniqueness, social value, innovation. Since 2006 they have collaborated with various Italian and non-Italian companies, such as Treemme Rubinetterie, Bertocci, as well as with Universities and research studies including Packlab - University of Milan and the University of Architecture of Florence for the Course of Furniture and Architecture of the interior. Phicubo has received several awards for the high quality in the relationship between design and ecology; in 2007 it was recognized as one of the 60 eco-efficient companies in the Tuscan territory with the Vespucci Prize, in 2012 they won the Plus Design Award in Frankfurt for the innovative design of the Philo Shower, and many other notes for the application of the principles of the 'Universal Design. The PIANTANE MOON collection, designed for Bertocci Industrie in 2016, is hilarious, cool, minimal and fun but at the same time functional : This is the mood of the new collection created by the collaboration between the two designers and architects Gianluca Belli and Alessandra Bertini with Bertocci. The project has the ambition to modify and shape the old technical concept of static and obsolete service platforms. The inspiration from the furniture world has created the first collection of stand accessories directly on the floor.



FABRIZIO NICCOLI e LORENZO BOSSIO

Fabrizio Niccoli, classe 1969, e Lorenzo Bossio, classe 1971, il primo nel tempo libero Maratoneta il secondo nel tempo libero Liutaio. Da sempre in Bertocci, da sempre con le mani in pasta per la costruzione, progettazione, ingegnerizzazione e industrializzazione di accessori bagno. Tutti e due uniti dal solito percorso formativo nato 30 anni fa (come primo lavoro) proprio in officina Bertocci Arnolfo per poi gradualmente diventare responsabili dell'ufficio tecnico e produttivo. Ancora oggi costituiscono l'ufficio tecnico Bertocci Industrie, con un mansionario molto allargato per Fabrizio che è anche responsabile di tutto il processo industriale e produttivo della azienda. Fin da giovanissimi hanno collaborato allo sviluppo, l'ingegnerizzazione, prototipazione e avviamento produttivo di tutte le serie firmate Bertocci e/o firmate dai designer e architetti di fama internazionale per Bertocci quali: Giancarlo Bartoli, Roberto Lazzeroni, Giancarlo Vegni, Carlo Urbinati,

Luca Bojola, Arch. Francesca Finocchi la cui serie "Arco" è stata catalogata dal "Cooper-Hewitt" National Museum of Design di New York, Meneghello & Paoletti la cui serie FLY è stata premiata dalla associazione ADI Associazione per il Disegno Industriale con il riconoscimento ADI DESIGN AWARD 2016. Questa grande passione oggi ha portato i due ragazzi a firmare il loro primo progetto chiamato EASY che sarà presentato nel corso del 2018.

Fabrizio Niccoli, born in 1969 and marathoner in his spare time, and Lorenzo Bossio, born in 1971 and luttist in his spare time have worked since ever in Bertocci giving a big contribution to the design, engineering and industrialisation of the new collections of bathroom accessories designed by internationally renowned designers and architects such as, Giancarlo Bartoli, Roberto Lazzeroni, Carlo Urbinati, Giancarlo Vegni, Luca Bojola, Francesca Finocchi, whose collection "Arco" has been catalogued by "Cooper-Hewitt" National Museum of Design in New York, and Meneghello & Paoletti, whose collectio FLY has been awarded with ADI Design Award. Bound together by the same training (their first job soon after the school was in the workshop at Bertocci Arnolfo), they have gradually become chiefs of the technical and production departments. Still today they represent the technical office at Bertocci Industrie and Fabrizio has enlarged his competence being today the chief of the whole industrial and productive process.

Their common passion has brought today Lorenzo and Fabrizio to sign their first project called EASY which is going to be presented in 2018.



ARCH. PAOLO SCHICCHI

Architetto, lavora da oltre trenta anni nel campo della progettazione architettonica. Ha progettato e realizzato numerosi interventi di edilizia privata residenziale, industriale e terziario. Si occupa di restauro e ristrutturazione edilizia fino alla progettazione di interni che lo ha portato a sviluppare la propria attività anche nel campo del design ed in particolare nel settore dell'arredo bagno. Per BERTOCCHI firma l'intramontabile serie ON-LINE che ad oggi è già diventata un must nel mondo dell'arredobagno.

Architect, has worked for over thirty years in architectural design, construction and interior design. He has carried out many projects in restoration and restructuring of a range of buildings (including historic and listed buildings) thus developing a specific interest in interiors and spinning off projects in industrial design. In particular, he has designed and realised products for home fittings and accessories, and recently has focused on bathroom accessories.



GIANCARLO VEGNI

Nasce a Grosseto nel 1949.

Nel 1968, conclusi gli studi, entra nel team della Ferretti Cucine. Poco dopo apre il suo studio che opera nel campo dell'industrial design e collabora con diverse aziende in Italia e all'estero, tra cui Effeti Cucine, Karol Bathroom, Rubinetterie 3M, Edra, Steel Time, Candy, Novamobili, Lema, Valli & Valli, Confalonieri, Casadesus, Fasem International e in alcune è anche art director.

Diversi progetti sono stati selezionati per il Compasso d'Oro, altri vincono premi come Design Plus, Neocon Chicago, Design Italiano.

Nei suoi progetti sono importanti la funzionalità e l'ergonomia. Predilige nel suo linguaggio creativo la forma tonda. L'iter del suo lavoro è concepire il prodotto per diversi stili di vita.

Oggi il suo studio oltre all'industrial design si occupa di comunicazione, di allestimenti fieristici e architettura d'interni residenziale e non, realizzando varie ville, appartamenti, showroom, uffici e negozi, tra cui gli outlet di Salvatore Ferragamo in tutto il mondo, uno stabilimento balneare e dei complessi residenziali con struttura smontabile, un autoveicolo elettrico di ingombro minimo a basso costo e un'imbarcazione media da diporto con materiali innovativi. Firma la collazione Plate

He was born in Grosseto in 1949.

In 1968, he completed his studies and joined the Ferretti Cucine team. Shortly after, he opens his studio in the field of industrial design and collaborates with several companies, sometimes as art director too, in Italy and abroad, including Effeti Cucine, Karol Bathroom, Rubinetterie 3M, Edra, Steel Time, Candy, Novamobili, Lema, Valleys, Confalonieri, Casadesus, Fasem International.

Some of his projects have been selected for the Compasso d'Oro, while others win prizes such as Design Plus, Neocon Chicago, Italian Design.

Functions and ergonomics are important in his projects. In his creative language, he prefers the round shape. His work is conceiving the product for different lifestyles.

Today, in addition to the industrial design, he focuses on communication, exhibition installations and residential and non-residential architecture, realizing various villas, apartments, showrooms, offices and shops, including Salvatore Ferragamo's outlets around the world, a seaside establishment and residential complexes with removable structure, a low-cost electric vehicle and a pleasure craft with innovative materials. For Bertocci he designs the collection Plate.

BERTOCCI

Bathroom Accessories

CENTO	14
CINQUECENTO	22
DUECENTO	44
ES	52
FLY	62
FREEZE	84
GOCCIA	96
GRACE	106
GRIMILDE	118
LEGER	136
MOON	144
ON LINE	156
ONLINE COMPONENTI	170
OVER	178
PLATE	184
POLO	202
SCACCO	216
SETTECENTO	226
VELA	240
QUADROTTO KIT	246
FILOTTO KIT	248
COMPLEMENTI	250

Prodotti disponibili in 9 finiture

cromo, nichel mat, oro mat, oro, oro rosa, bronzo, nero mat, bianco mat, rosso bertocci mat vedi listino di vendita

Products available in 9 finishes: chrome, nickel mat, gold mat, gold, rose gold, black mat, white mat and red bertocci mat (see pricelist)

Produkte in 9 Ausführungen erhältlich : Chrom, Nickel matt, Gold matt, Gold, Roségold, Bronze, Schwarz matt, Weiß matt, Rot Bertocci matt (siehe Verkaufspreisliste)

Produits disponibles en 9 finitions : chrome, nickel mat, or mat, or, or rose, bronze, noir mat, blanc mat, bertocci rouge mat (voir le traif de vente)

Productos disponibles en 9 acabados : cromo, níquel mate, oro mate, oro, oro rosa, bronce, negro mate, blanco mate, bertocci roja mate (ver lista de precios de venta)





CENTO

DESIGN OFFICINA BERTOCCHI

LA SEMPLICITA' SPESSO
NASCONDE
DOTI INASPETTATE.

The simplicity often hides unexpected qualities
Die Einfachheit oft versteckt unerwartete Eigenschaften
La simplicité cache souvent des propriétés inattendues
Simplicidad a menos ocultos con inesperados.





Cod. 112
Cod. 121

Accessori dal design lineare e contemporaneo. Completa personalizzazione.

Linear and contemporary design accessories
Lineares und zeitgemäßes Designzubehör
Accessoires de design linéaire et contemporain
Accesorios con un diseño lineal y contemporáneo. Completa personalización.



Cod. 103
Cod. 121

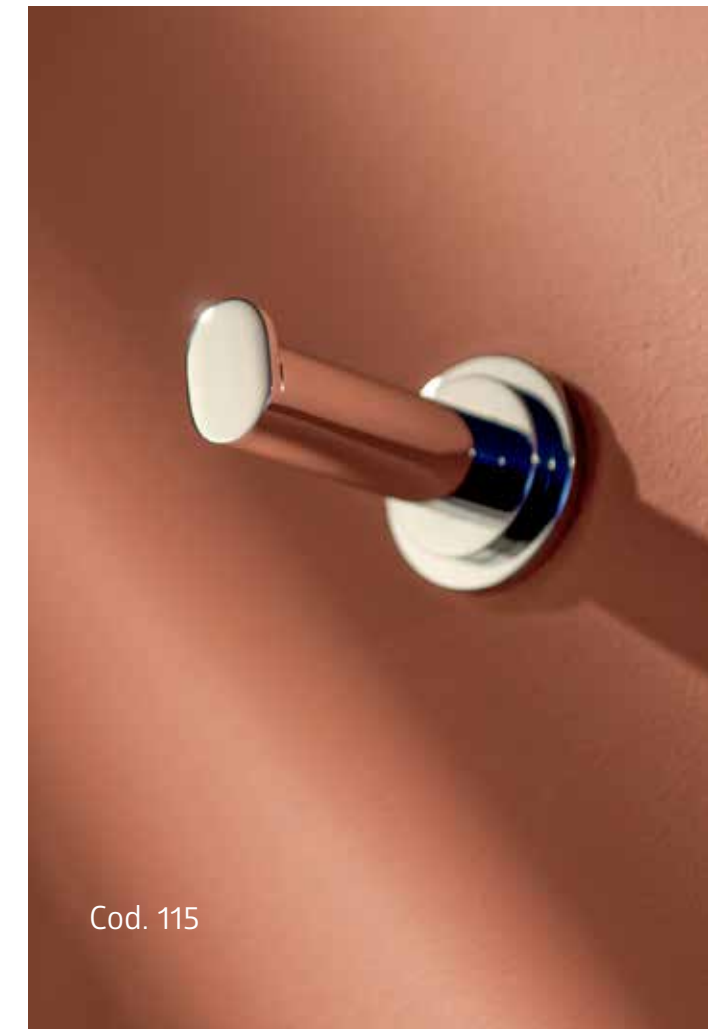

Cod. 115



Cod. 8501

Forme semplici, estremamente funzionali,
facili da pulire.

Simple shapes, extremely functional, easy to clean.

Einfache, extrem funktionale und leicht zu reinigende Formen.

Forme simples, extrêmement fonctionelles et faciles à nettoyer.

Formas simples, extremadamente funcionales, fáciles de limpiar.



Cod. 8120



CINQUECENTO

DESIGN OFFICINA BERTOCCI

INTRAMONTABILE, COME LE
COSE CHE NASCONO CON
INTELLIGENZA.

Timeless as things born with intelligence.

Zeitlos wie alle Dinge mit Intelligenz geboren.

Sans temps, comme tous les choses nées avec intelligence.

Intramontable, como le cosas que nacimiento con inteligencia.



Pietra miliare, da sempre.

A landmark since ever. - Immer ein Markstein. - Un repère, toujours. - Milestone, siempre.



Cod. 535



Cod. 517

20 anni di garanzia sulle finiture cromo e garanzia a vita sul montaggio.

20 years warranty on chrome finishes and lifetime warranty on assembling.
20 Jahre Garantie auf Chromoberflächen und lebenslange Garantie auf Montage.
20 ans de garantie sur les finitions chromées et garantie a vie sur l'assemblage.
20 años de garantía en acabados de cromo y garantía de por vida en el montaje.



Un progetto storico, che non smette mai di stupire.

A historic project, that never ceases to astonish.
Ein historisches Projekt, das nie zu erstaunen aufhört.
Un project historique qui ne cesse jamais d'étonner.
Un proyecto histórico que nunca deja de sorprender.



Cod. 500



Cod. 544



Vedi pag. 36

Funzionalità, flessibilità, stile intramontabile.

Functionality, flexibility and timeless style.
Funktionalität, Flexibilität und zeitloser Styl.
Functionnalité, flexibilité et style intemporel.
Funcionalidad, flexibilidad, estilo atemporal.



Cod. 501



Cod. 535



Cod. 528

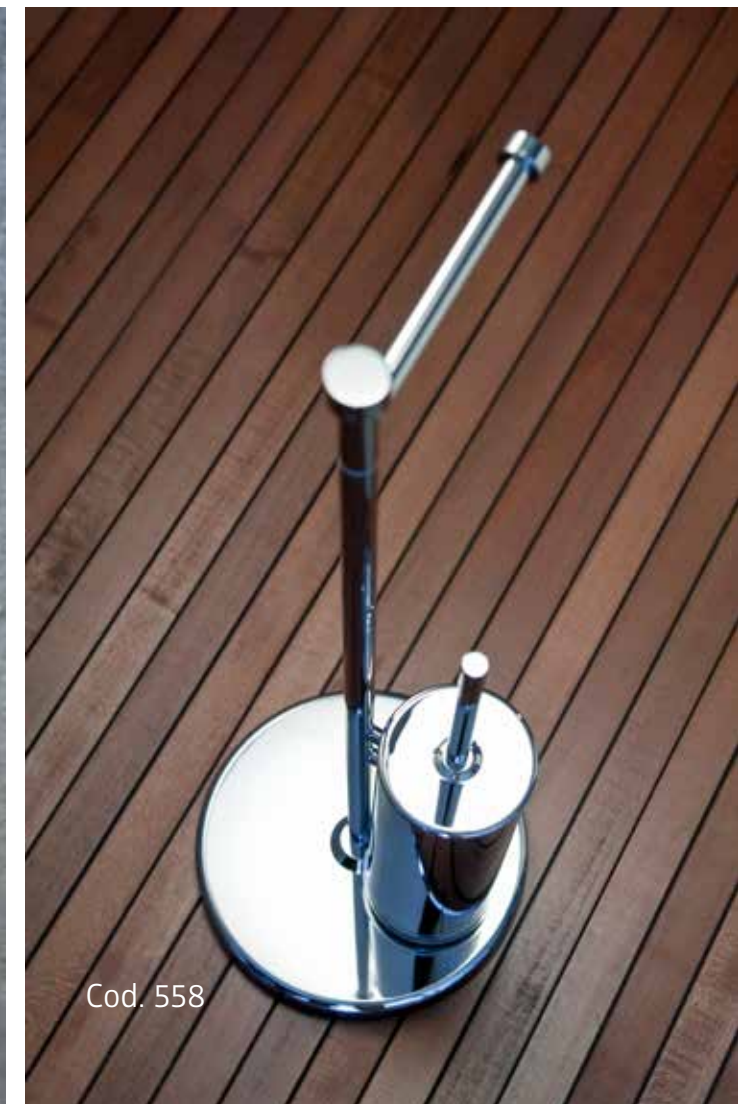

Cod. 558

Il design funzionale

Funtional design. - Funktionelles design. - Designe fonctionel. - Diseño funcional

Anche lo spazio doccia è servito.
“Cinquecento” pensa a tutto.

Even the shower room is served.
“Cinquecento” thinks of everything.

Auch die Duschkabine ist gedient.
“Cinquecento” denkt an alles.

Même la salle de douche est servie:
“Cinquecento” pense à tout.

También se sirve el espacio de la ducha.
“Cinquecento” piensa en todo.





Comp. n° 10
Foto originale 1991

Progettato nel 1990:
I capolavori non invecchiano mai.



Cod. 516

Designed in 1990: masterpieces never grow old.
1990 gezeichnet: Meisterwerke werden nie alt.
Dessiné en 1990: les chefs - d'oeuvre ne vieillissent jamais.
Diseñado en 1990: Las obras maestras nunca envejecen.



Cod. 503



Cod. 503

Progetta il tuo spazio 100 % personalizzabile.

Design your space - 100% customizable.

Gestalten Sie Ihres Raum - 100% anpassbare.

Concevez votre espace - 100% personnalisable.

Diseña tu espacio - 100% personalizable

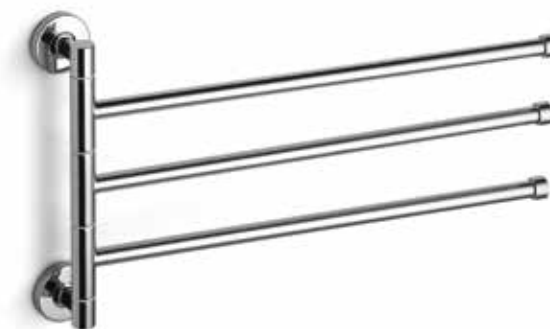



Utilizzo di foratura esistente

Tutti gli accessori della serie “Cinquecento” possono essere adattati per utilizzare i fori esistenti.

Exploitation of existing drilling

All “Cinquecento” accessories can be adapted to use existing holes.



Verwendung der vorhandenen Bohrungen

Alle Zubehöre der Serie “Cinquecento” können “angepasst” werden, um vorhandene Löcher zu verwenden.

Utilisation du percement existant

Tous les accessoires de la série “Cinquecento” peuvent être personnalisés pour utiliser les trous existants.

Uso de perforación existente

Todos los accesorios en la serie “Cinquecento” se puede adaptar para usar agujeros existentes.

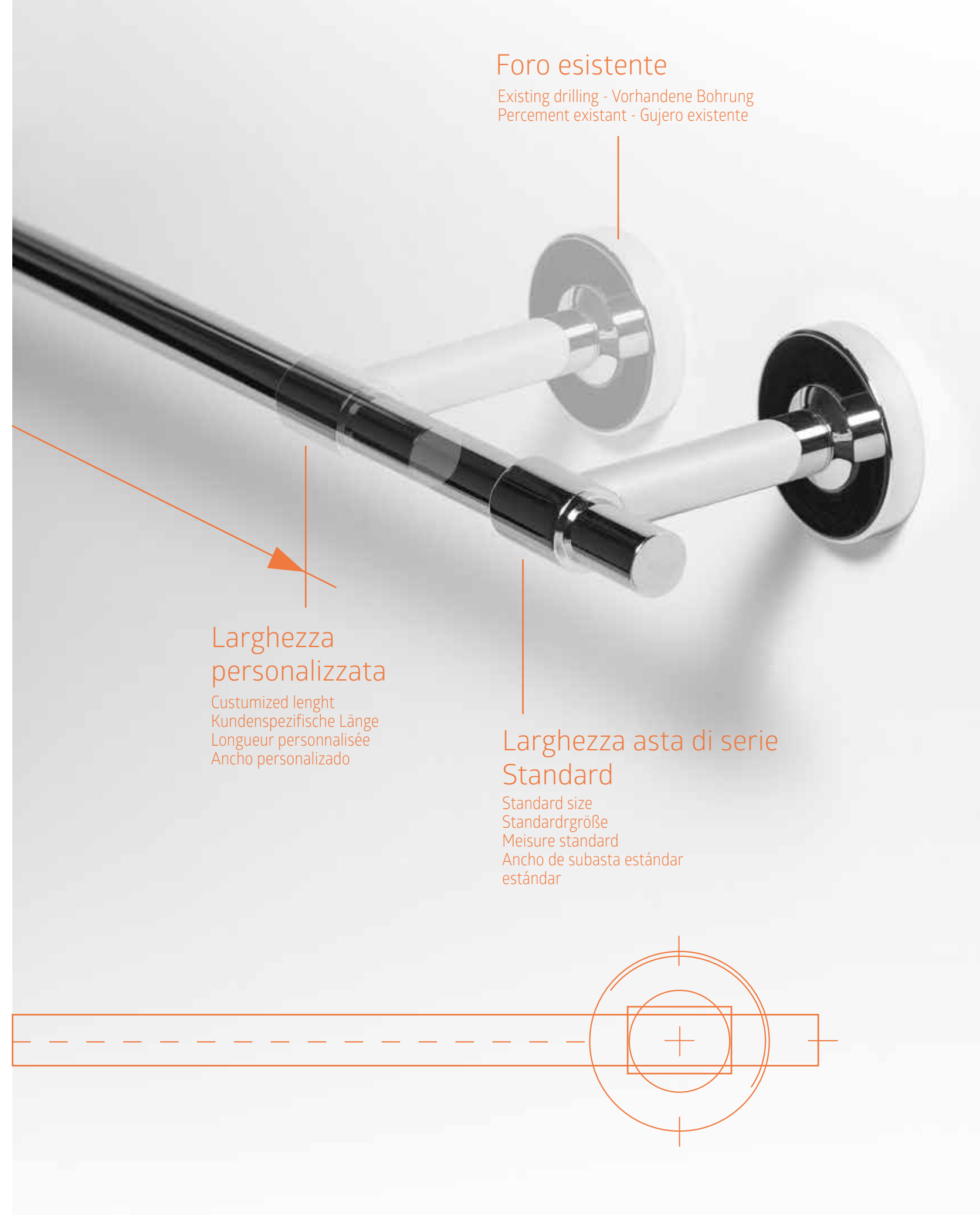

CINQUECENTO

technical Info



Cod. 500 - (9,5 x ø 8 cm.)



Cod. 530 - (10,5 x ø 8 cm.)



Cod. 501 - (ø 13 cm.)



Cod. 575 - (ø 4 cm.)



Cod. 523 - (49 x 13 cm.)



Cod. 516 - (36 x 6,5 cm.)
Cod. 517 - (51 x 6,5 cm.)
Cod. 518 - (66 x 6,5 cm.)



Cod. 531 - (2,5 x ø 13 cm.)



Cod. 528 - (15 x h. 9 x ø 5 cm.)



Cod. 548 - (15,5 x ø 5 cm.)



Cod. 533 - (16 cm.)
Cod. 534 - (33 cm.)

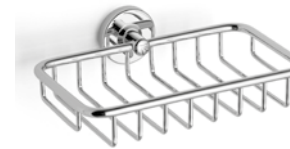

Cod. 572 - (22 x h. 3 x 12 cm.)



Cod. 535 - (23 x h.22 cm.)



Cod. 503 - (16 x h.9 x 7,5 cm.)



Cod. 508 - (16 cm.)



Cod. 547 - (16 x h.4 x 7,5 cm.)



Cod. 536 - (37 x h.16 cm.)



Cod. 514 - (h. 40 x ø 8 cm.)



Cod. 574 - (h.36 x 12 x ø 9 cm.)



Cod. 505 - (31 x h.4 x 7,5 cm.)



Cod. 504 - (16 x h.24 x 7,5 cm.)



Cod. 515 - (8 x 4 cm.)



Cod. 524 - (18 x h.22 x 18 cm.)



Cod. 525 - (18 x h.36 x 18 cm.)



Cod. 579 - (55 x h.15 x 30 cm.)

CINQUECENTO

technical Info



Cod. 540 - (30 x h.62 x 15 cm.)



Cod. 544 - (60 x h.60 x 8 cm.)



COMP. N°1 - (45 x 13,5 cm.)



COMP. N° 2 - (60 x 13,5 cm.)



Cod. 576 - (38 max x ø 19 cm.)



Cod. 569 - (19 x h. 35 x 15 cm.)

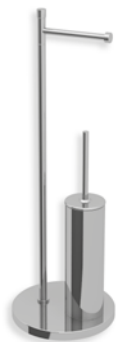

Cod. 558 - (h.64,5 x ø 21,5 cm)



Cod. 559 - (h.80 x ø 21,5 cm)



COMP. N° 10 - (15,5 x ø 85 cm.)



COMP. N° 25 - (15,5 x ø 85 cm.)



Cod. 560- (h.90 x ø 26 cm)



Cod. 561- (h.170 x ø 26 cm)

Note



DUECENTO

DESIGN OFFICINA BERTOCCI

ESSENZIALE, MODERNA E
AFFASCINANTE.

Essential, modern and fascinating.
Essentiel modern und faszinierend.
Essentiel, modern et fascinant.
Esencial, moderno y con encanto.





Cod. 261
Cod. 8528



Cod. 265



Cod. 261

Il design che si adatta ad ogni spazio.



The design that fits every space. - Das Design das zu jedem Raum passt.
Le design qui s'adapte a tous les espace. - El diseño que se adapta a cualquier espacio.



DUECENTO

technical Info



Cod. 8500 - a parete (8 x h.13 x 8 cm.)
Wall-mounting/ Wandelemente/ Mural/ De pared
Cod. 8530 - da appoggio (8 x h.13 x 7 cm.)
Countertop/ Standelemente/ A poser/ De apojo



Cod. 8501 - a parete (12 x h.4 x 10 cm.)
Wall-mounting/ Wandelemente/ Mural/ De pared
Cod. 8531 - da appoggio (12 x h.4 x 9 cm.)
Countertop/ Standelemente/ A poser/ De apojo



Cod. 8528 - a parete (8 x h.19 x 8.)
Wall-mounting/ Wandelemente/ Mural/ De pared
Cod. 8528 - da appoggio (8 x h.19 x 7.)
Countertop/ Standelemente/ A poser/ De apojo



Comp. 292 - (14 x h.24 x 24 cm.)



Cod. 3493 - (18 x h.84,5 x 29,5 cm.)



Cod. 263 - (21 x 7,7 cm.)



Cod. 265 - (2,3 x h. 9 x 4 cm.)



Cod. 266 - (6 x h.2,5 x 4 cm.)



Cod. 261 - (40 x 5,5 cm.)
Cod. 262 - (60 x 7,5 cm.)



Cod. 3437 - (26 x h.19 cm.)
Cod. 3438 - (35 x h.19 cm.)



Comp. 233 - (26 x h.28 cm.)



Comp. 234 - (26 x h.24 cm.)



Cod. 271 - a parete (8,5 x h.42,5 x 10,2 cm.)
Wall-mounting/ Wandelemente/ Mural/ De pared
Cod. 272 - da terra (8,5 x h.42,5 x 9,2 cm.)
Free standing/ Standmodell/ Sur pied/ De pie



Cod. 270 /8270 - da terra (h.65 x 16,7 x ø 10 cm.)
Free standing/ Standmodell/ Sur pied/ De pie

Note



ES

DESIGN LUCA BOJOLA

UN SEGNO SEDUCENTE,
CON FORTE PERSONALITA',
SU TUTTI GLI ACCESSORI.

A seductive sign with strong personality on all accessories.

Ein verführerisches Zeichen mit einer starken Personalität.

un signe séduisant, avec une forte personnalité, sur tous les accessoires.

Una señal seductiva, con fuerte personalidad, en todos los accesorios.



Estroverso e seducente, il progetto "ES" sa distinguersi.

Outstanding and seductive, the "ES" project can stand out.
Extravagant und verführerisch, kann das Projekt "ES" sich abheben.
Extravagant et séduisant, le projet "ES" peut se démarquer.
Extrovertido y seductor, el proyecto "ES" sabe cómo sobresalir.



Cod. 4030
Cod. 4011



Cod. 4035



Cod. 4011



Cod. 4030

Ogni accessorio è unico,
esclusivo e raffinato.



Cod. 4000

Each accessory is unique, exclusive and refined.
Jeder Stuck ist einzigartig, exklusive und raffiniert.
Chaque accessoire est unique, exclusif et raffiné.
Cada accesorio es único, exclusivo y refinado.

Materia piegata al volere della forma

Material bent at the will
of the form

Materie nach dem
Willen der Form
gebogen

Matériel plié a' la
volonte de la forme

Material doblado a la
voluntad de la forma



ES

technical Info



Cod. 4000 - (8,5 x h.11 x 10 cm.)



Cod. 4001 - (11,8 x h.5 x 13 cm.)



Cod. 4028 - (7,5 x h.18 x 10 cm.)



Cod. 4021 - (9,5 x h. 53 x ø 11,5 cm.)



Cod. 4022 - (h. 53 x ø 12 cm.)



Cod. 4090 - (h. 64,5 x ø 21,5 cm.)

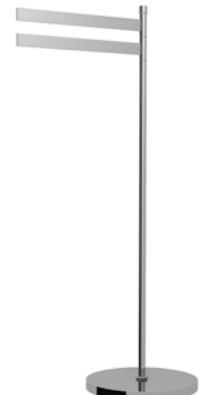

Cod. 4093 - (h. 85 x ø 26 cm.)



Cod. 4030 - (h.11 x ø 8 cm.)



Cod. 4031 - (ø 11,8 cm.)



Cod. 4048 - (h.18,5 x ø 6 cm.)



Cod. 4003 - (16 x h.4 x 8 cm.)



Cod. 4005 - (25 x h.4 x 6 cm.)
dx/ right/ rechts/ droite/ dch
Cod. 4085 - (25 x h.4 x 6 cm.)
sx/ left/ links/ gauche/ izq



Cod. 4013 - (43 x h.4 x 6 cm.)
Cod. 4011 - (60 x h.4 x 6 cm.)



Cod. 4036 - (39 x h. 18,5 x 37 cm.)



Cod. 4014 - (4 x h. 8,5 x 6 cm.)



Cod. 4015 - (4 x h. 13,5 x 7 cm.)





FLY

DESIGN MENEGHELLO PAOLELLI ASSOCIATI

UN VOLO DI FANTASIA,
MA FUNZIONA TUTTO,
ALLA GRANDE.

A fantasy flight where everything works great .
Ein Fantasy-Flug wo alles super funktioniert.
Un vol de fantaisie où tout fonctionne très bien .
Un vuelo de fantasía, pero funciona todo, para el grande.

A
D
I
C
E
R
A
M
I
C
D
E
S
I
G
N
A
W
A
R
D
2
0
1
6



A D I
C E R A M I C
D E S I G N
A W A R D
2 0 1 6





Un sistema dalle infinite composizioni.

A system with innumerable compositions.
Ein System mit unendlichen Kompositionen.
Un système de compositions infinies.
Un sistema de composiciones infinitas.



ADI
CERAMIC
DESIGN
AWARD
2016

Fly serie giovane.

Fly, young collection.
Fly, Junge Kollektion.
Fly: jeune collection.
Fly: series jóvenes.





Lo specchio organizza lo spazio.

The mirror which organizes your space.
Der Spiegel, der ihrem Raum organisiert.
Le miroir qui organise votre espace.
El espejo organiza el espacio.

Multimaterica, multifunzione.

Multimaterial, multifuntional. - Multi-stoffe und multifunktional.

Multimateriaux et multifonctionnel. - Multifunción, mutiplase.





L'accessorio non è statico, ma dinamico

The accessory is not static, but dynamic

Das Zubehör ist nicht statisch, sondern dynamisch

L'accessoire n'est pas statique mais dynamique

El accesorio no es estático sino dinámico

A D I
C E R A M I C
D E S I G N
A W A R D
2 0 1 6

FLY

technical Info

PASSAGGIO 1

FISSARE IL PROFILO **ELEMENTO 1** A MURO. VITERIA E FISSAGGI A VISTA

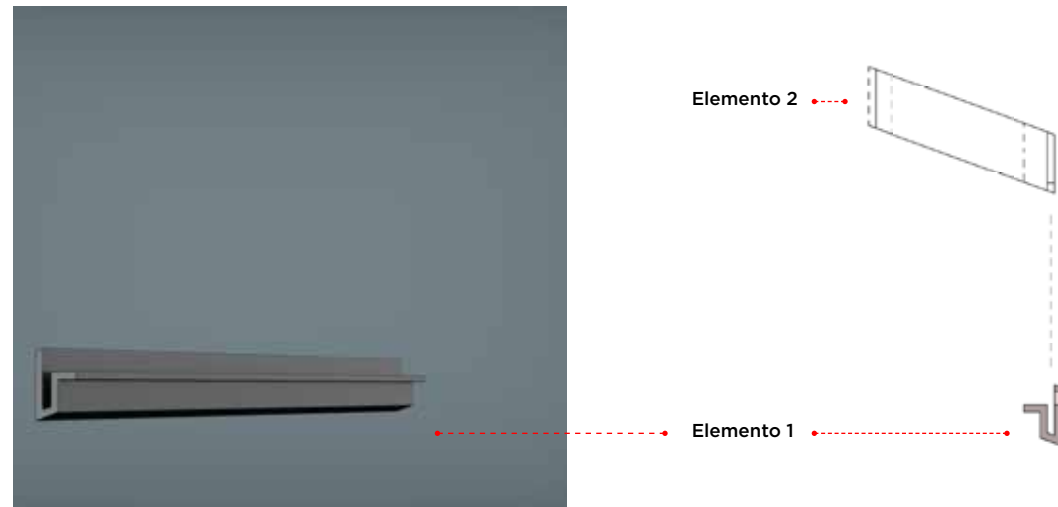

SISTEMA ACCESORI BAGNO
FLY

PASSAGGIO 2

SI INCASTRA LA FASCIA A 45° (**ELEMENTO 2**) DENTRO **L'ELEMENTO 1**.
COSÌ FACENDO ABBIAMO SIA "CREATO IL SISTEMA" MA ANCHE NASCOSTO I FISSAGGI E LA VITERIA

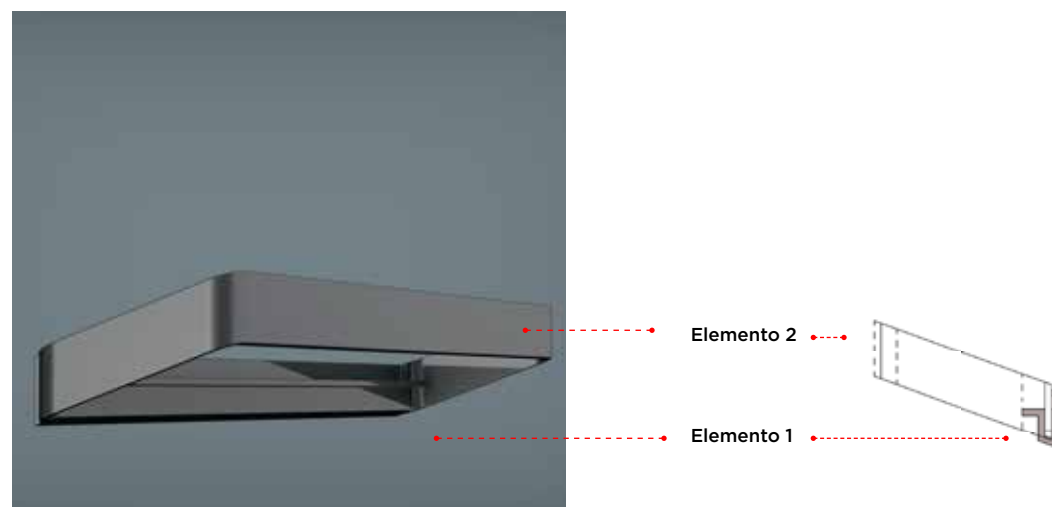

SISTEMA ACCESORI BAGNO
FLY

PASSAGGIO 3

L'ACCESSORIO (**ELEMENTO 3**) SI INNESTRA E SI BLOCCA TRA **L'ELEMENTO 1** E **L'ELEMENTO 2** DANDO UN SENSO DI ILLUSIONE E LEGGEREZZA.

L'ELEMENTO 1 NON È SOLO BARRA DI FISSAGGIO **BENSÌ ANCHE BASE DI APPOGGIO DELL'ELEMENTO 3**.



SISTEMA ACCESORI BAGNO
FLY

L'accessorio si appoggia sul fronte
sull' **Elemento 2** e sulla base
sull' **Elemento 1**

L'ACCESSORIO (**ELEMENTO 3**) SI INNESTRA E SI BLOCCA TRA **L'ELEMENTO 1** E **L'ELEMENTO 2** DANDO UN SENSO DI ILLUSIONE E LEGGEREZZA.

L'ELEMENTO 1 NON È SOLO BARRA DI FISSAGGIO **BENSÌ ANCHE BASE DI APPOGGIO DELL'ELEMENTO 3**.



SISTEMA ACCESORI BAGNO
FLY

L'accessorio si appoggia sul fronte
sull' **Elemento 2** e sulla base
sull' **Elemento 1**

La struttura in metallo ha 3 finiture diverse: Nichel Matt, Bianco, Nero, che possono essere combinate agli accessori bianchi, marroni, neri e grigi. Combinazioni infinite.

The metal bar is available 3 different colours : Nickel Matt, black and white, that can be combined with the resin elements available in white, black, grey and beige. Innumerable combinations.

Die Metallstange ist in 3 verschiedenen Farben zur Verfügung: Nichel Matt, Schwarz und Weiß, die mit den weißen, beigen, grauen oder schwarzen Elementen kombiniert werden können. Unendliche Kombinationen.

La barre de métal est disponible en 3 finitions différentes: nickel matt, noir et blanc qui peuvent être combinés avec les complements en resine blanc, beige, grise ou noire.

El marco de metal tiene 3 diferentes acabados: níquel matt, blanco, negro, que se puede combinar con blanco, marrón, negro, gris. Interminables combinaciones



FLY

technical Info



Cod. 1500 - (7 x h.11 x 7 cm.)

Finiture resina:

Bianco
Grigio blu
Beige
Nero



Cod. 1528 - (7 x h.17 x 7 cm.)

Finiture resina:

Bianco
Grigio blu
Beige
Nero

Finiture metallo:

Cromo
Bronzo
Oro
Oro Mat
Oro Rosa
Nichel Mat
Bianco
Nero

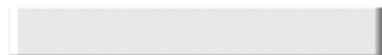

Cod. 1506 - (28 x h.3,5 x 7cm.)

Finiture resina:

Bianco
Grigio blu
Beige
Nero

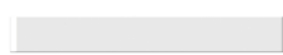

Cod. 1501 - (14 x h.3,5 x 7 cm.)

Finiture resina:

Bianco
Grigio blu
Beige
Nero



Cod. 1522 - (8,5 x h.47 x 8,5 cm.)

Finiture resina:

Bianco
Grigio blu
Beige
Nero

Finiture metallo:

Cromo
Bronzo
Oro
Oro Mat
Oro Rosa
Nichel Mat
Bianco
Nero



Barra

Cod. 1502 - (7 x h.2,5 x 8 cm.)
Cod. 1510 - (14 x h.2,5 x 8 cm.)
Cod. 1511 - (21 x h.2,5 x 8 cm.)
Cod. 1512 - (28 x h.2,5 x 8 cm.)
Cod. 1513 - (42 x h.2,5 x 8 cm.)
Cod. 1514 - (56 x h.2,5 x 8 cm.)



Portabiti

Cod. 1515 - (3 x h. 6 x 6 cm.)

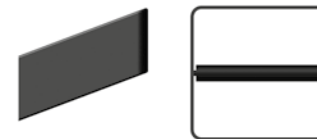

Portarotolo

Cod. 1503 - (13 x h.2,5 x 13 cm.)



Portascopino

Cod. 1521 - (8,5 x h. 2,5 x 9,5 cm.)



Portarotolo + portasalviette + portaoggetti (Piccolo)

Cod. 1505 - (34 x h.2,5 x 13 cm.)
dx/ right/ rechts/ droite/ dch
Cod. 1504 - (34 x h.2,5 x 13 cm.)
sx/ left/ links/ gauche/ izq

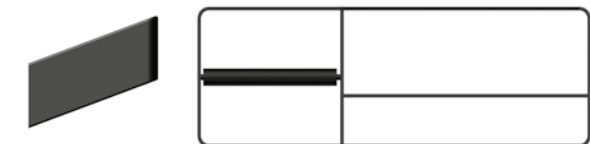

Portarotolo + portasalviette + portaoggetti (Piccolo)

Cod. 1508 - (41 x h.2,5 x 13 cm.)
dx/ right/ rechts/ droite/ dch
Cod. 1507 - (41 x h.2,5 x 13 cm.)
sx/ left/ links/ gauche/ izq

FLY

technical Info

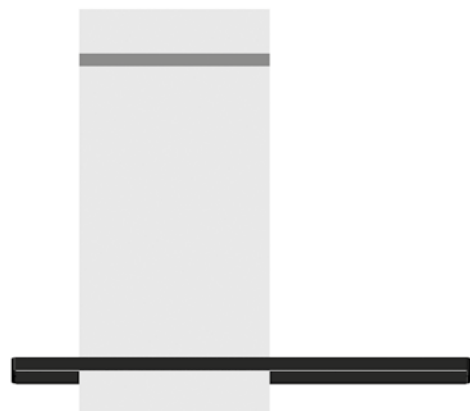

COMP. 1649
Posizionamento specchio libero SX/DX e illuminazione LED
Barra 96 cm + Specchio 40 x h.80 cm.

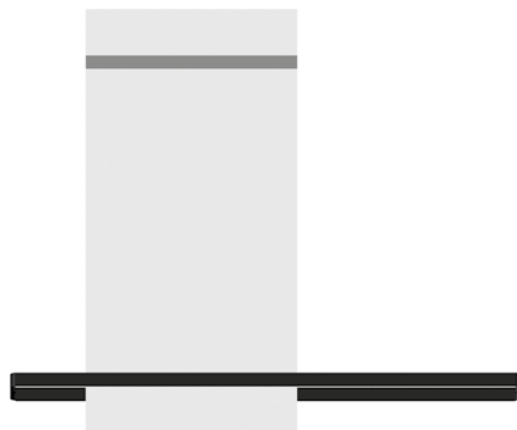

COMP. 1650
Posizionamento specchio libero SX/DX e illuminazione LED
Barra 96 cm + Specchio 40 x h.80 cm.

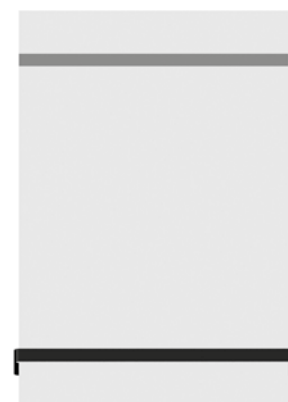

COMP. 1651
Specchio con portasalviette e illuminazione LED
Barra 56 cm + Specchio 55 x h.80 cm.

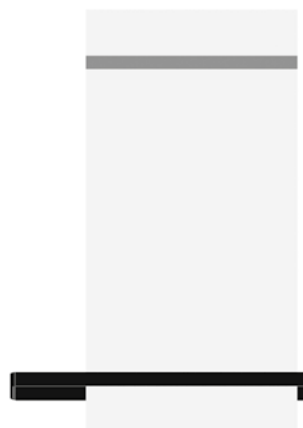

COMP. 1652
Posizionamento specchio libero SX/DX e illuminazione LED
Barra 56 cm + Specchio 40 x h.80 cm.

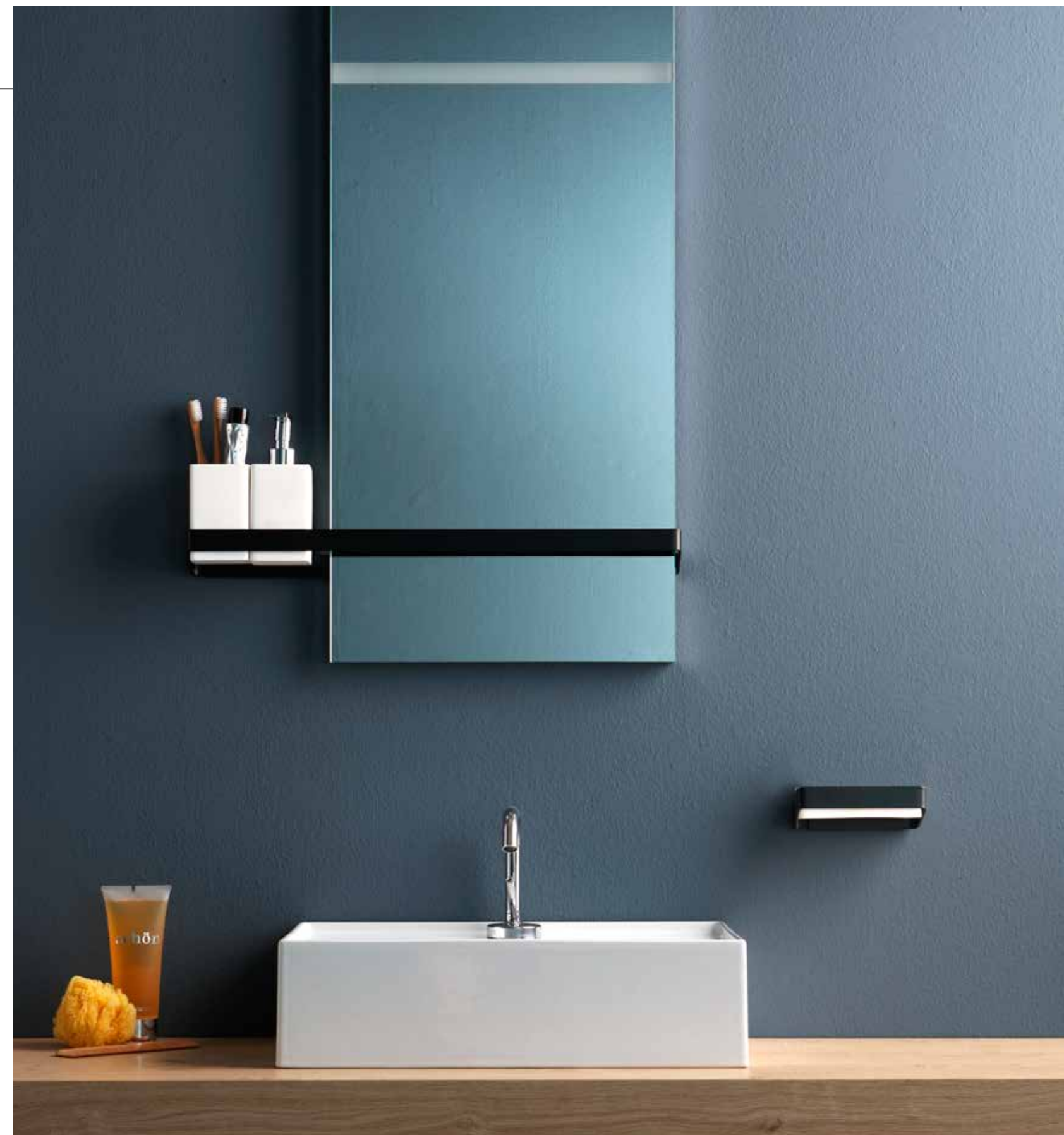



FREEZE

DESIGN MENEGHELLO PAOLELLI ASSOCIATI

UN TAGLIO DECISO, LASCIA
SPAZIO AD UN DESIGN
SPIGOLOSO E DIAMANTINO.

A sharp cut that allows for an edgy and diamond design.

Ein entscheidender Schnitt, woher ein Kühnes und rautenförmiges Design ergibt.

Une coupe décisive, résultant en un design audacieux et en forme.

Un corte decisivo, deja espacio para un diseño espiguloso y de diamante.



Geometrie forti, plasmate con un materiale innovativo: il Neolyteck.

Strong geometries, molded with an innovative material: the Neolyteck
Starke Geometrien, mit einem innovativen Material geformt: das Neolyteck
Géométries robustes, moulés avec un matériau innovant: le Neolyteck
Geometrías fuertes, moldeadas con un material innovador: los Neolyteck



Cod. 1722



Cod. 1748



Cod. 1731

Una finitura cromo stupefacente.

An amazing chrome finish. - Ein erstaunliches Verchromung.

Une finition chromée incroyable - Un incroyable acabado cromado



Sempre in Neolyteck, il lavabo Freeze ha lo stesso stile degli accessori.



Always in Neolyteck, the Freeze washbasin has the same style of accessories.
Immer aus Neolyteck, hat das Becken Freeze die gleiche Art der Zuberhören .
Toujours en Neolyteck, le lavabo Freeze a le même style d'accessoires.
Siempre en Neolyteck, el lavabo Freeze tiene el mismo estilo de accesorios.

Specchio con cornice
e illuminazione led integrata.



Cod. 1711
Cod. 1780
Cod. 1700
Cod. 1728

Cod. 1721
Cod. 1703

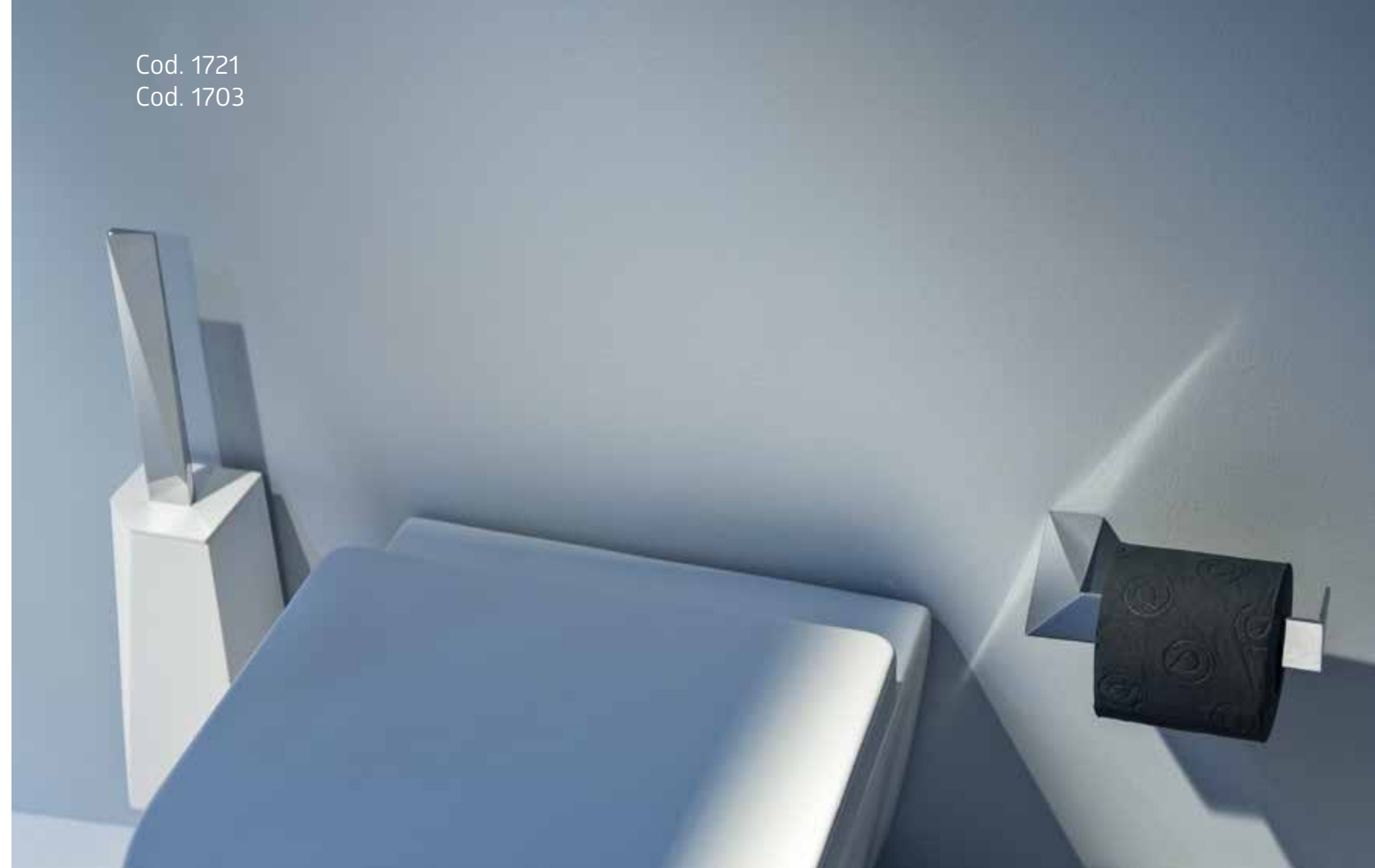

Mirror with frame and integrated led lighting.
Spiegel mit Rahmen und integrierter Led Beleuchtung.
Miroir avec cadre et illumination a Led intégrée.
Espejo con marco y LED de iluminación integrada.

FREEZE

technical Info



Cod. 1700 - A parete (8 x h.13 x 9 cm.)
Wall-mounting/ Wandelemente/ Mural/ De pared
Cod. 1730 - Da appoggio (8 x h.13 x 8 cm.)
Countertop/ Standelemente/ A poser/ De apojo



Cod. 1701 - A parete (14,5 x h.3,5 x 9,5 cm.)
Wall-mounting/ Wandelemente/ Mural/ De pared
Cod. 1731 - Da appoggio (14,5 x h.3,5 x 8,5 cm.)
Countertop/ Standelemente/ A poser/ De apojo



Cod. 1728 - A parete (8 x h.18 x 9 cm.)
Wall-mounting/ Wandelemente/ Mural/ De pared
Cod. 1748 - Da appoggio (8 x h.18 x 8 cm.)
Countertop/ Standelemente/ A poser/ De apojo



Cod. 1703 - (h.17,5 x h.3,5 x 8 cm.)



Cod. 1711 - (40 x h.3,5 x 8 cm.)
Cod. 1712 - (60 x h.3,5 x 8 cm.)



Cod. 1715 - (3,5 x h.7,8 x 6 cm.)



Cod. 1721 - A parete (9 x h.43,5 x 10 cm.)
Wall-mounting/ Wandelemente/ Mural/ De pared
Cod. 1722 - Da terra (9 x h.43,5 x 9 cm.)
Standing/ Standbürstengarnitur/ à poser/ de pie



COMP. 1780 - (85 x h.45 x 5 cm.)

Note



GOCCIA

DESIGN OFFICINA BERTOCCI

RIEDIZIONE DI UN DISEGNO ORIGINALE BERTOCCI.

Forma ideata dall'ingegner Bartoli nel 1986.

Re-edition of an original project by Bertocci.
Wiederausgabe eines originellen design Bertocci.
Ré edition d'un design original Bertocci.
Reducción del diseño original Bertocci.





Complementi in Neoliteck.

Elemetes in Neoliteck - Elemente aus Neoliteck - Complémentes en Neoliteck - Complementos en Neoliteck.





Cod. 8120
Cod. 8211



Cod. 8120

Forma spaziale e intuitiva che sembra indicare una direzione: il tuo stile.

Space and intuitive form that seems to point a direction: your style.
Raum und intuitive Form, die eine Richtung zeigt: ihr Stil.
Space et forme intuitive qui indique une direction: votre stile.
Espacio y forma intuitiva que se ve como indica una dirección: tu estilo.

Tutti gli accessori ruotano a 180°



Cod. 8211

All accessories rotate at 180° - Alle Zubehöre drehen sich um 180°
Tous les accessoires tournent à 180° - Todos los accesorios giran a 180°



Cod. 8200
Cod. 8228

GOCCIA

technical Info



Cod. 8200 - (8 x h.13 x 9 cm.)



Cod. 8201 - (10 x h.3 x 11 cm.)



Cod. 8228 - (8 x h.12 x 8 cm.)



Cod. 8320 - (h.65 x 17,7 x ø 10 cm.)



Cod. 8270 - (h.68 x 16,7 x ø 10 cm.)



Cod. 8120 - (h.65 x 15,7 x ø 10 cm.)



Cod. 8230 - (8 x h.12 x 8 cm.)



Cod. 8231 - (10 x h.2 x 10 cm.)



Cod. 8248 - (8 x h.18 x 8 cm.)



Esempi di componibilita



Esempi di componibilita



Cod. 8211 - (18 x h.22 x 4 cm.)
Cod. 8212 - (25 x h.30 x 4 cm.)



Cod. 8213 - (25 x h.30 x 11 cm.)



Cod. 8110 - (h.66 x 15 x ø 10 cm.)



Cod. 8250 - (75 x h.75 cm.)



Cod. 8251 - (75 x h.75 cm.)



GRACE

DESIGN OFFICINA BERTOCCI

ELEGANTE, UN PO'
ARISTOCRATICO, PERCHE' IL
FASCINO NON GUASTA MAI.

Elegant and a bit aristocratic, because charme never fails.

Elegant und ein bisschen aristokratisch, weil Charme nie versagt.

Élegant, et un peu aristocratique parce que charme ne manque jamais.

Elegante, año aristocrático, por qué el fascino no falló.



Vagamente retrò, elegante in ogni singolo dettaglio.



Cod. 7705
Cod. 7728+7702
Cod. 7703
Cod. 7722+7721



Cod. 7722+7721

Vaguely retro, elegant in every single detail.
Retro und elegant jedem Detail.
Vaguement rétro et elegant dans chaque detail.
Vagamente retro, elegante en cada detalle.



Cod. 7700+7702
Cod. 7701+7702

Ceramica bianca oppure nera, abbinata al cromo lucidissimo.
Grace sui colori non scherza.



Cod. 7700+ 7702
Cod. 7728+ 7702

White or black ceramic, combined with polished chrome. Grace on colors does not joke.
Weißes oder schwarzes Keramik mit poliertem Chrom kombiniert. Farben sind kein Witz.
Céramique blanche ou noire, combinée avec du chrom poli. les couleurs ne sont pas une blague.
Cerámica blanca o negra, combinada con cromo pulido. Grace en colores no es broma.

Tutto coordinato, tutto bellissimo.



All coordinated, beautiful. - Alles koordiniert und schön.
Tout coordonné et beau. - Todo coordinado, todo hermoso.



Grace parla il linguaggio “classico-moderno”.

Grace speaks the language of “modern-classics”.
Grace spricht die Sprache des “modern klassik”.
Grace parle le langage “classique-moderne”.
Grace habla el lenguaje “clásico moderno”.



GRACE

technical Info

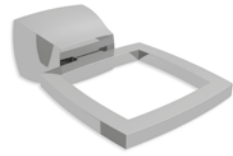

Cod. 7702 - (8,3 x h.4,5 x 13,2 cm.)



Cod. 7700 - (8 x h.11 x 8 cm.)



Cod. 7701 - (12 x h.3,5 x 8 cm.)

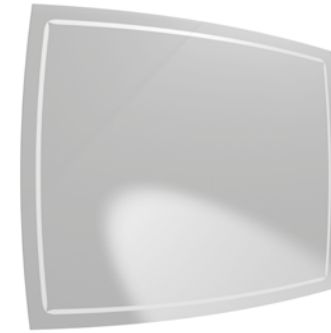

Cod. 7750 - (90 x h.70 cm.)



Cod. 7752 - (90 x h.60 cm.)

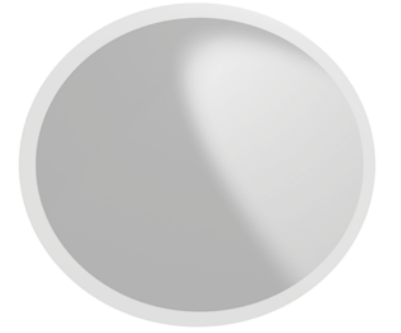

Cod. 7754 - (75 x h.65 cm.)



Cod. 7728 - (8 x h.16 x 8 cm.)



Cod. 7703 - (14,5 x h.8 cm.)



Cod. 7715 - (6,5 x h.7 x 7,5 cm.)



Cod. 7705 - (25 x h.16,5 x 7,5 cm.)

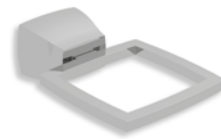

Cod. 7721 - (10 x h.4,5 x 15 cm.)



Cod. 7711 - (41 x h.4,5 x 7,5 cm.)
Cod. 7712 - (65 x h.4,5 x 7,5 cm.)
Cod. 7713 - (85 x h.4,5 x 7,5 cm.)



Cod. 7722 - (10 x h.41 x 10 cm.)



Cod. 7726 - (17 x h.22 x 22,5 cm.)

Note



GRIMILDE

DESIGN STEFANO BERTOCCI con GERALDINE NALDINI

UNICA E RAFFINATA.
QUANDO IL DESIGN GUARDA
AL LUSSO.

Unique and refined. When design looks at luxury.
Einzigartig und raffiniert. Wenn das Design auf Luxus schaut.
Unique et raffiné. Quand le design regarde le lux
Único y refinado. Cuando diseño mira al lujo.





Cod. 9047



Cod. 9012

Recuperare i segni autentici della classicità, in tempi moderni: ecco Grimilde.

To recover the authentic signs of classicity in modern times: here is Grimilde.

Erholen Sie die authentischen zeichen der Klassik in der Neuzeit das ist Grimilde.

Récupérer les signes authentiques de la classicité dans les temps modernes: voila Grimilde.

Recuperando los signos auténticos de la clasicidad, en los tiempos modernos: aquí está Grimilde.

Valore estetico straordinario.



Cod. 9080

Extraordinary aesthetic value. - Außergewöhnlicher ästhetischer Wert.
Valeur esthétique extraordinaire. - Valor estético extraordinario.



Cod. 9048

Unica nel panorama arredobagno,
la collezione Grimilde concilia innovazione con
tradizione.



Unique in the bathroom, the Grimilde collection combines innovation with tradition.
Einzigartig in Badeeinrichtung, kombiniert die Kollektion Grimilde innovation und Tradition.
Unique dans la salle de bain la collection Grimilde ailié innovation et tradition.
Único en el baño interior, la colección Grimilde reconcilia la innovación con la tradición.



Cod. 9003



Cod. 9022

Finitura oro 24 k (carati) design di lusso.

24 carat gold finish, luxury design.

24 karat Gold, Luxus Design.

Finition or 24 carats, design de luxe.

Diseño de lujo con acabado dorado de 24 k (quilates).



Cod. 9012



Cod. 9012
Cod. 9080
Cod. 9048

Grimilde riesce ad avere anche uno stile più hard: laccato nero o bianco mat.

Grimilde also has a harder style: black mat or white mat laquered.

Grimilde hat auch ein härteren Stil: schwarz matt oder weiss matt lackiert.

Grimilde a aussi un styl plus bizarre: laqué blanc ou noir.

Grimilde también tiene un estilo más duro: negro lacado o blanco mate.



Cod. 9080

Affascinante ovunque.



Cod. 9047

Fascinating everywhere. - Überall faszinierend.
Fascinant partout. - Encantador en todas partes.



Cod. 9048
Cod. 9030



Cod. 9080
Cod. 9048

Grimilde



GRIMILDE

technical Info



Cod. 9000 - (15,7 x h.10,8 x 10,4 cm.)



Cod. 9080 - (15,7 x h.10,8 x 10,4 cm.)



Cod. 9001 - (15,7 x h.10 x 10,4 cm.)



Cod. 9011 - (36 x h.10 x 13,4 cm.)
Cod. 9012 - (45 x h.10 x 13,4 cm.)
Cod. 9012 - (55 x h.10 x 13,4 cm.)

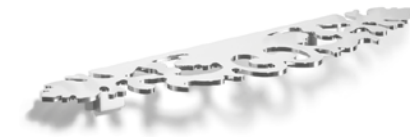

Cod. 9006 - (40 x h.3,4 x 10 cm.)
Cod. 9007 - (50 x h.3,4 x 10 cm.)



Cod. 9015 - (5,8 x h.8,3 x 5,4 cm.)



Cod. 9081 - (15,7 x h.10 x 10,4 cm.)



Cod. 9028 - (15,7 x h.17,1 x 10,4 cm.)



Cod. 9088 - (15,7 x h.17,1 x 10,4 cm.)



Cod. 9021 - (h.45,2 x 10,5 x ø 8,8 cm.)



Cod. 9022 - (h.45,2 x ø 8,8 cm.)



Cod. 9047 - (16 x h.28 cm.)



Cod. 9003 - (15,7 x h.10 x 13,4 cm.)



Cod. 9083 - (15,7 x h.10 x 13,4 cm.)



Cod. 9030 - (10,6 x h.9 x 10,6 cm.)

Note



Cod. 9031 - (15,2 x h.2,5 x 9,2 cm.)



Cod. 9048 - (10,6 x h.16,1 x 10,6 cm.)



Cod. 9002 - (45 x h.10 x 13,4 cm.)



LEGER

DESIGN LUCA BOJOLA

RETRO' NELLE FORME,
MODERNO NELLE FUNZIONI.

Design retro, modern in the functions.
Retrodésigne, Modern in der Funktion
Design rétro, modern en les fonctions
Retro 'en los formularios, moderno en funciones..





Cod. 3004

Linee morbide, seducenti, ma estremamente funzionali.

Soft and seductive lines, but extremely functional.

Weiche und verführerische Linien, aber extrem funktional.

Lignes douces et séduisantes mais extrêmement fonctionelles.

Líneas suaves, seductoras, pero extremadamente funcionales.



Cod. 3000



Cod. 3031

Un pò Giapponese, ma
con molta anima italiana.



Cod. 3011

A little bit japanese, but with 100 % italian soul.
Etwas japanisch, aber mit 100% italienischer Seele.
Un peu japonais, mais avec 100% d'âme italienne .
Un poco de japonés, pero con mucho alma italiana.

LEGER

technical Info



Cod. 3000 - (h.11 x 12 x ø 8 cm.)



Cod. 3001 - (11 x h.6 x 13 cm.)



Cod. 3028 - (h.16 x 11 x ø 7 cm.)



Cod. 3030 - (h.11 x ø 8 cm.)



Cod. 3031 - (11 x h.5 x 11 cm.)



Cod. 3048 - (h.16 x ø 7 cm.)

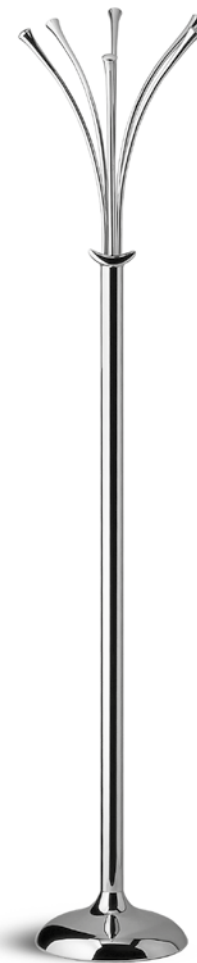

Cod. 3094 - (h.166 x ø 37 cm.)

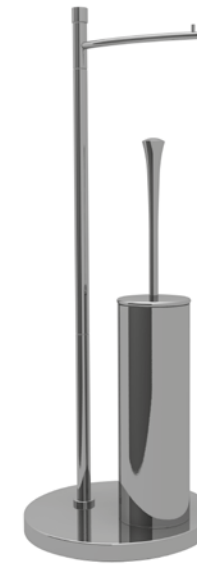

Cod. 3390 - (h.64,5 x ø 21,5 cm.)

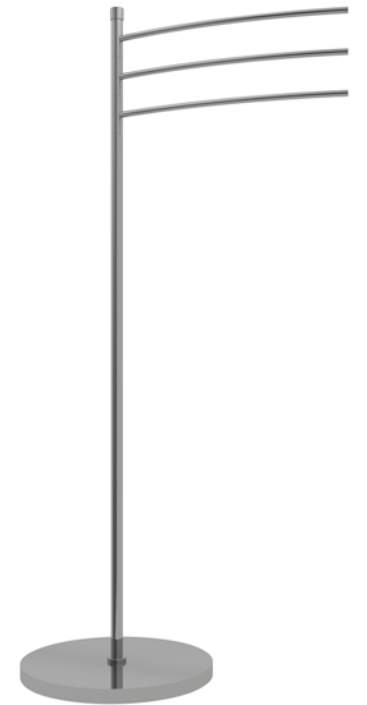

Cod. 3393 - (h.90 x ø 26 cm.)



Cod. 3003 - (16 x h.5,5 x 7 cm.)



Cod. 3004 - (24 x h.20 x 5 cm.)



Cod. 3011 - (53 x h.5,5 x 6 cm.)



Cod. 3037 - (27,5 x h.20 cm.)
Cod. 3036 - (37,5 x h.20 cm.)



Cod. 3015 - (8 x h.5,5 x 6 cm.)



Cod. 3023 - (h.43 x ø 8 cm.)

Note



MOON

DESIGN GIANLUCA BELLI E ALESSANDRA BERTINI

PROGETTO GIOVANE , IRRIVERENTE. UN NUOVO CONCETTO PER PIANTANE DI SERVIZIO

Young and irreverent project. A new point of view of service stands .
Junges und respektloses Progekt. Ein neuer Blickwinckel auf das Konzept der Service Ständer.
Projet jeune et irrévérencieux. Un nouveau point de vue sur le concept de planches del service.
Proyecto juventud, irrivering. un nuevo concepto de piedras de servicio.





Cod. 374









Cod. 375



Cod. 378

MOON

technical Info



Cod. 370 - (15 x h.74 x 12 cm.)

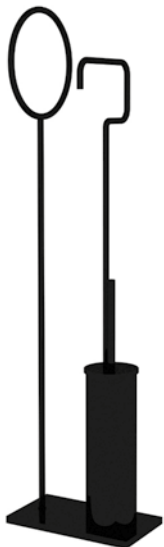

Cod. 371 - (22 x h.83 x 12 cm.)

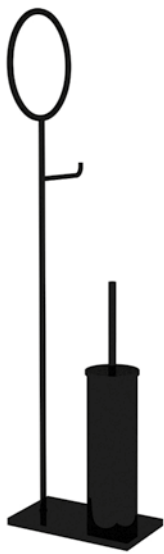

Cod. 372 - (22 x h.83 x 12 cm.)

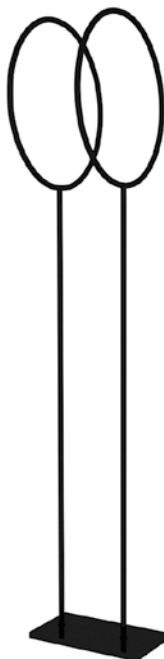

Cod. 376 - (22 x h.110 x 12 cm.)



Cod. 377 - (22 x h.83 x 12 cm.)

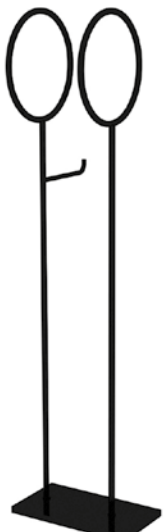

Cod. 378 - (22 x h.83 x 12 cm.)

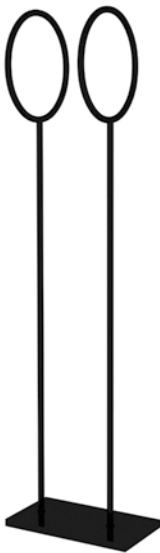

Cod. 373 - (22 x h.83 x 12 cm.)

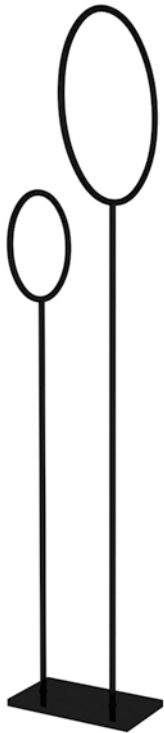

Cod. 374 - (22 x h.110 x 12 cm.)

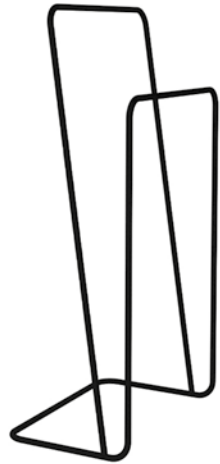

Cod. 375 - (35 x h.70 x 23 cm.)



Cod. 349 - (h.40 x ø 8 cm.)



ON LINE

DESIGN ARCHITETTO PAOLO SCHICCHI

INFINITE SOLUZIONI
FINO ALLA MASSIMA
COMPONIBILITA'.

Endless solutions to maximum componibility.
Unendliche Lösungen für maximale Modularität.
Solutions infinies pour une modularité maximale.
Soluciones infinitas hasta la componibilidad máxima.





Cod. 2500



Cod. 2005
Cod. 2500
Cod. 2518



Preferisci il sapone tradizionale, oppure quello liquido da dispenser?

Do you prefer the traditional soap or the liquid one for dispenser?

Bevorzugen Sie die traditionelle Seifen oder die flüssige für den Seifenspender?

Préférez vous le savon traditionnel ou le savon liquide pour le dispenser?

¿Prefiere el jabón tradicional o el dispensador de líquidos?



3 materiali per una personalizzazione estrema.

3 materials for an extrem customization.
3 Materialien für eine extreme Personalisierung.
3 Matériaux pour une personnalization extreme.
3 materiales para uno personalización extrema.



CRISTALLO trasparente.
clear cristal - transparenter kristall
cristal transparent -cristal Transparente.



CRISTALLO satinato.
satin cristal - satin kristall
cristal satin -cristal satinado



CERAMICA.
ceramic - Keramik
céramique - cerámica



Cod. 2005
Cod. 2500
Cod. 2518



Cod. 2621

Moderno, ordinato, razionale

Modern, tidy, rational - Modern, ordentlich, rational
Moderne, bien rangé, rationell - Moderno, ordenado, racional





La personalità di un progetto la riconosci quando ti assomiglia. ON LINE è il tuo bagno.

The personalty of a project can be recognised when it looks like you. ON LINE is your bathroom.

Man kann die Persönlichkeit eines Projektes erkennen, wenn sie wie du aussieht. ON LINE ist Ihr Badezimmer.

Vous reconnaissez la personnalité d'un projet quand vous ressemble. ON LINE este votre salle de bain.

La personalidad de un diseñador reconoce cuando se parece a ti. ON LINE es tu baño.





Cod. 2005

Le forme squadrate di ON LINE ne fanno il protagonista nella casa contemporanea.

The square shapes of ON LINE make it the protagonist in the contemporary home.

Die quadratischen Formen der Kollektion machen ihn zum Protagonisten im zeitgenössischen Hausen.

Les formes carrées de la collection en font le protagoniste de la maison contemporaine.

Las formas cuadradas de ON LINE lo convierten en el protagonista de la casa contemporánea.



Elementi singoli oppure componibili all'infinito:
ON LINE è un progetto dentro al progetto.



Single or infinite elements: ON LINE is a project within the project.
Einzelne oder unendliche Elemente. ON LINE ist ein Projekt im Projekt.
Éléments uniques ou infinis. ON LINE est un projet dans le projet.
Elementos únicos o infinitos: ON LINE es un proyecto dentro del proyecto.





Componibilità
infinita
tutto sartoriale

Endless modularity
Unendliche Modularität
Modularité infinie
Infinita modularidad

Una linea continua, che segue le funzioni necessarie ad un bagno contemporaneo.



A continuous line that follows the functions needed for a contemporary bath.
Eine ununterbrochene Linie, die für ein zeitgenössisches Bad benötigte Funktionen, folgt.
Une ligne continue qui suit les fonctions nécessaires pour le bain contemporain.
Una línea continua que sigue las funciones necesarias para un baño contemporáneo.



ON LINE

technical Info



COMP. 2500 - (12,5 x h. 12 x 10 cm.)



COMP. 2500 - (21,3 x h. 3,5 x 10 cm.)



COMP. 2528 - (12,5 x h. 18,5 x 10 cm.)



COMP. 2517 - (50 x h. 3,5 x 10 cm.)



Cod. 2003 - (16,5 x h.2,5 x 7 cm.)



Cod. 2004 - (16,5 x h.2,5 x 10 cm.)

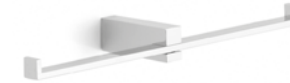

Cod. 2002 - (25,5 x h.2,5 x 7 cm.)



Cod. 2072 - (36 x h.2,5 x 10 cm.)

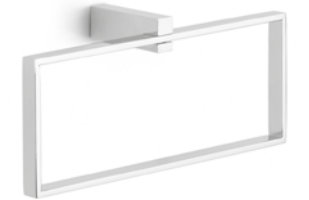

Cod. 2005 - (25 x h.10 x 7 cm.)

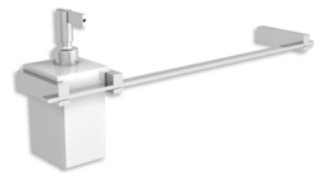

COMP. 2518 - (50 x h. 18,5 x 10 cm.)



COMP. 2621 - (14,8 x h. 45 x 10 cm.)



COMP. 2570 - (29,3 x h. 12 x 10 cm.)



COMP. 2560 - (29,3 x h. 12,9 x 10 cm.)



Cod. 2011 - (35 x h.2,5 x 7 cm.)
Cod. 2012 - (50 x h.2,5 x 7 cm.)
Cod. 2013 - (59 x h.2,5 x 7 cm.)



Cod. 2135 - (22 x h.9,5 cm.)



Cod. 2037 - (22 x h.9,5 cm.)
Cod. 2036 - (30 x h.9,5 cm.)



Cod. 2015 - (1,5 x h.2,5 x 7 cm.)



COMP. 2516 - (40 x h. 12,9 x 10 cm.)



Cod. 2030 - (8 x h.12 x 8,5 cm.)



Cod. 2031 - (16,8 x h.2,5 x 8,5 cm.)



Cod. 2048 - (8 x h.18,5 x 8,5 cm.)



Cod. 2123 - (8 x h.48 x 8 cm.)
Cod. 2124 - (8 x h.48 x 8 cm.)



Cod. 2047 - (15 x h.15 x 28 cm.)



Cod. 2147 - (15 x h.35 x 15 cm.)



Cod. 2043 - (38 x h.50 x 7 cm.)



Cod. 2121 - (10 x h.45 x 8,5 cm.)



Cod. 2130 - (6 x h.12 x 6 cm.)



Cod. 2131 - (12 x h.1,5 x 7,5 cm.)



Cod. 2148 - (6 x h.18,5 x 6 cm.)



Cod. 2390 - (14 x h.63 x 24 cm.)



Cod. 2391 - (14 x h.76 x 24 cm.)



Cod. 2393 - (18 x h.88 x 29,5 cm.)



Cod. 2395 - (29,5 x h.165 x 29,5 cm.)



OVER

DESIGN OFFICINA BERTOCCI

MINIMALE, DI CARATTERE

Minimal and firm.

Minimal und entschlossen.

Minimal et déterminé.

Minimo, carácter





Cod. 8500
Cod. 8501

Ogni accessorio è unico,
esclusivo e raffinato.



Cod. 8503



Cod. 8515

Each accessory is unique, exclusive and refined.
Jeder Zubehör ist einzig, exklusiv und raffiniert.
Chaque accessoire est unique, exclusif et raffiné.
Cada accesorio es único, exclusivo y refinado..



PLATE

DESIGN GIANCARLO VEGNI

INCONFONDIBILE CON LA SUA
DINAMICA INCLINATA.

Unmistakable with its sloping shape.
Unverwechselbar mit seiner schrägen Form.
Reconnaisable par sa forme inclinée.
Desconectado con su dinámica inclinada.



Design contemporaneo



Contemporary designer. - Zeitgenössisches Design.
Design contemporain. - Diseño contemporáneo.





Cristallo e superfici cromate ad arte,
ne fanno un superbo oggetto di design.

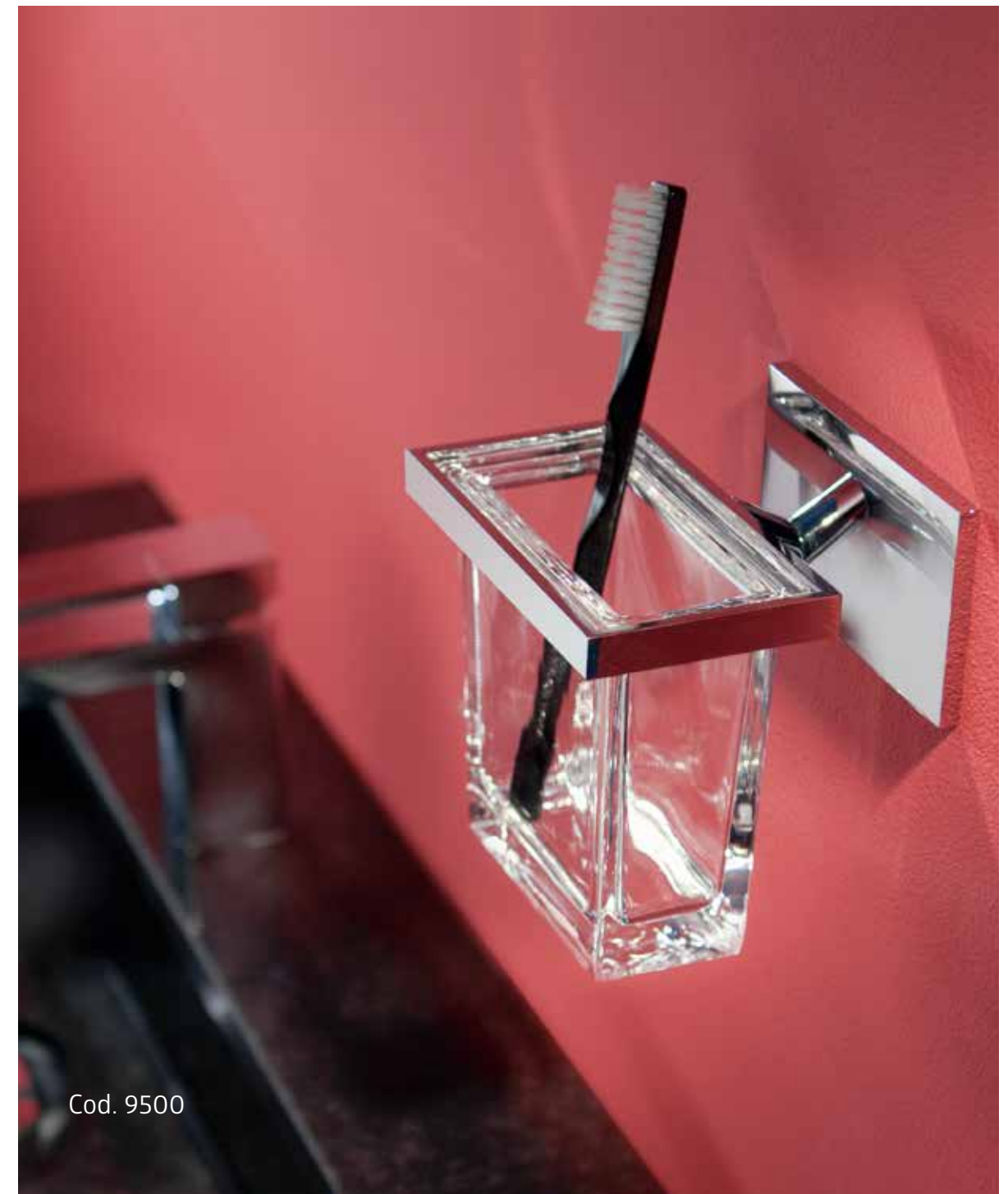

Glass and chrome-plated surfaces make it a superb design object.
Kristall und verchromte Oberflächen, machen es zu einem hervorragenden Designobjekt.
Le Cristal et les surfaces chromées, en font un superbe objet design.
Cristal y superficies cromadas, que sea un excelente objeto de diseño.

Segno dinamico, inconfondibile, che nasce dalla forma inclinata del suo supporto. Tutto sembra in movimento.



Dynamic, unmistakable sign that is born from the inclined dynamic of its support. Everything is moving.
Ein dynamisches und unmissverständliches Zeichen, das aus der geneigten Form seiner Unterstützung geboren ist.
Alles ist Bewegung.
Un signe dynamique et indubitable qui anît de la forme inclinée de son support. Tout est en mouvement.
Signo dinámico e inconfundible que nace de la dinámica inclinada de su soporte. Todo se está moviendo

Niente è lasciato al caso, ogni componente riflette lo spirito innovativo.

Nothing is left to chance, each component reflects the innovative spirit.

Nichts wird dem Zufall überlassen, jede Komponente spiegelt ihrem innovativen Geist .

Rien n'est laissé au hasard, chaque élément reflète l'esprit d'innovation.

No se deja nada al azar, cada componente refleja el espíritu innovador.



Cod. 9590

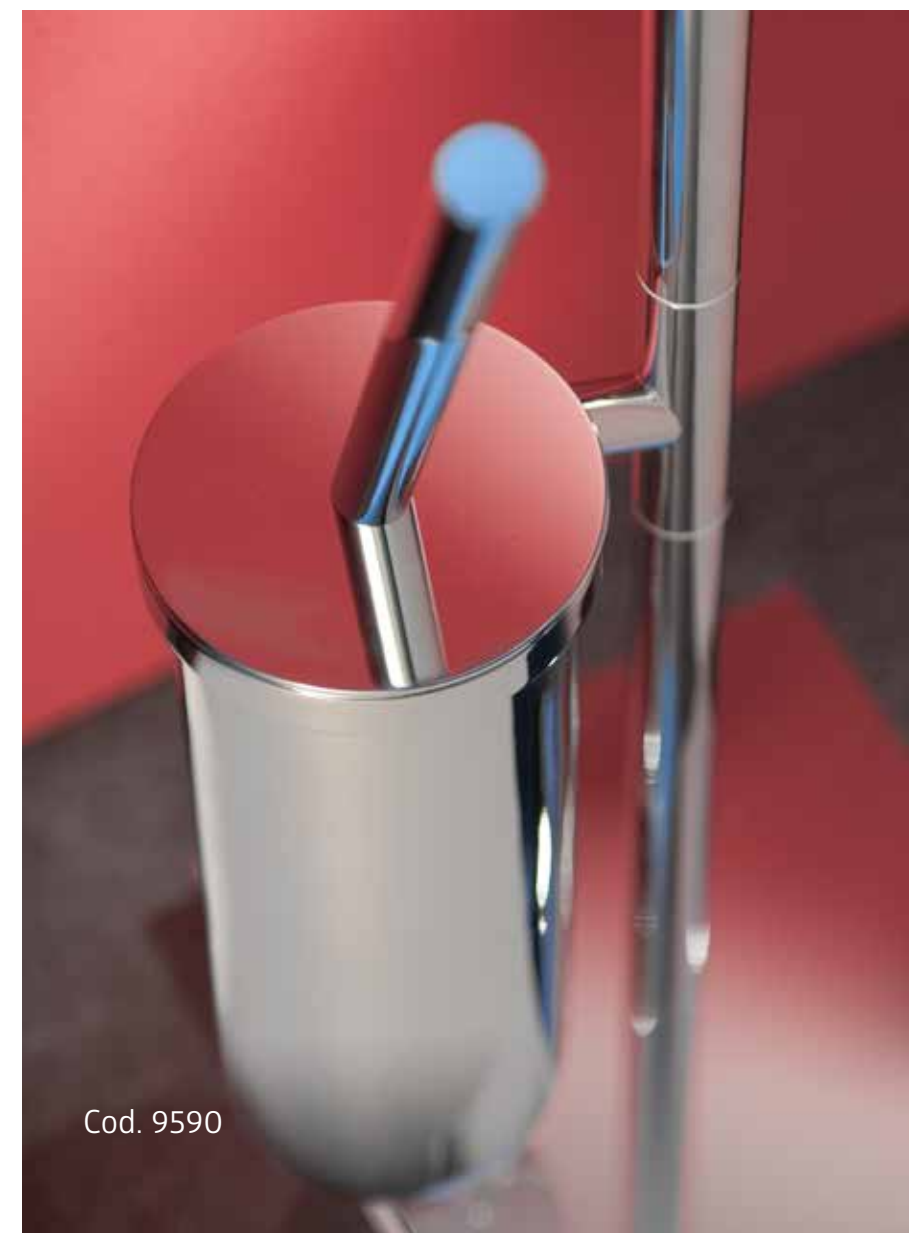

Cod. 9590



Cod. 9591

Dal più complesso al più semplice.
La piantana super funzionale, oppure
l'appendiabito: carattere riconoscibile.

From the most complex to the simplest.
The super functional stand, or the hook, recognizable
character.

Vom komplexesten zu einfachsten. Die super funktionale
Handtuchstand oder die Wandhaken.

Du plus complexe au plus simple.
La porte-serviette sur pied ou le porte-manteau

De lo más complejo a lo más simple.
La súper planta funciona, o la percha: personaje
reconocible.



Cod. 9515

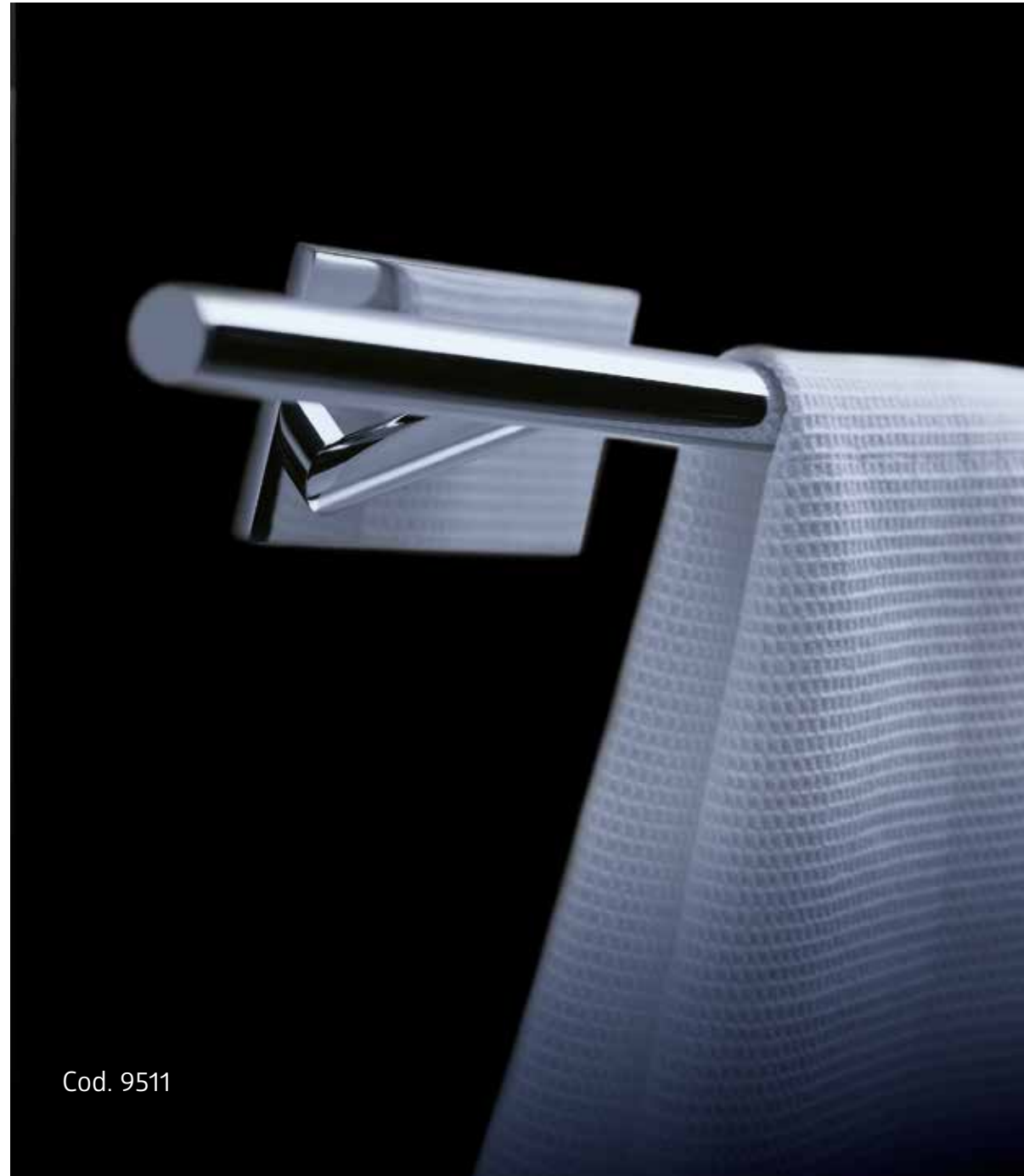

Cod. 9511



Cod. 9531
Cod. 9548
Cod. 9530



PLATE

technical Info



Cod. 9500 - (14 x h.14 x 9 cm.)



Cod. 9501 - (14 x h.6 x 12 cm.)



Cod. 9528 - (14 x h.16 x 9 cm.)



Cod. 9535 - (24,5 x h.29,5 x 26,5 cm.)



Cod. 9536 - (34,5 x h.22,5 x 36,5 cm.)



Cod. 9515 - (10 x h.6 x 4 cm.)



Cod. 9530 - (11 x h.12 x 6 cm.)

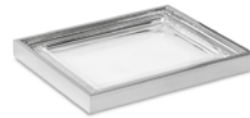

Cod. 9531 - (12 x h.2 x 10 cm.)



Cod. 9548 - (11 x h.16 x 6 cm.)



Cod. 9506 - (30 x h.6 x 14,5 cm.)



Cod. 9508 - (60 x h.6 x 14,5 cm.)



Cod. 9521 - (13 x h.35 x 11 cm.)

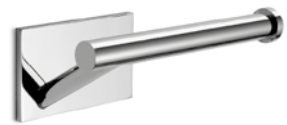

Cod. 9503 - (17 x h.7 x 9 cm.)



Cod. 9504 - (18 x h.10 x 13 cm.)



Cod. 9502 - (40 x h.9 x 12 cm.)
dx/ right/ rechts/ droite/ dch
Cod. 9582 - (40 x h.9 x 12 cm.)
sx/ left/ links/ gauche/ izq



Cod. 9522 - (8 x h.40 x 8 cm.)



Cod. 9540 - (40 x h.67 x 16 cm.)



Cod. 9590 - (16 x h.57 x 16 cm.)



Cod. 9511 - (40 x h.6 x 7 cm.)



Cod. 9512 - (50 x h.6 x 7 cm.)



Cod. 9516 - (50 x h.6 x 7 cm.)
Cod. 9517 - (65 x h.6 x 7 cm.)



Cod. 9591 - (16 x h.69 x 16 cm.)



Cod. 9593 - (22 x h.86 x 22 cm.)



POLO

DESIGN OFFICINA BERTOCCI

VOLUMI E SUPERFICI SI
FONDONO CON EQUILIBRIO

Volumes and surfaces are equilibrated

Volumes und Oberflächen vermischen sich im Gleichgewicht

Les volumes et les surfaces se mélangent en équilibre

Los volúmenes y las superficies se mezclan en equilibrio

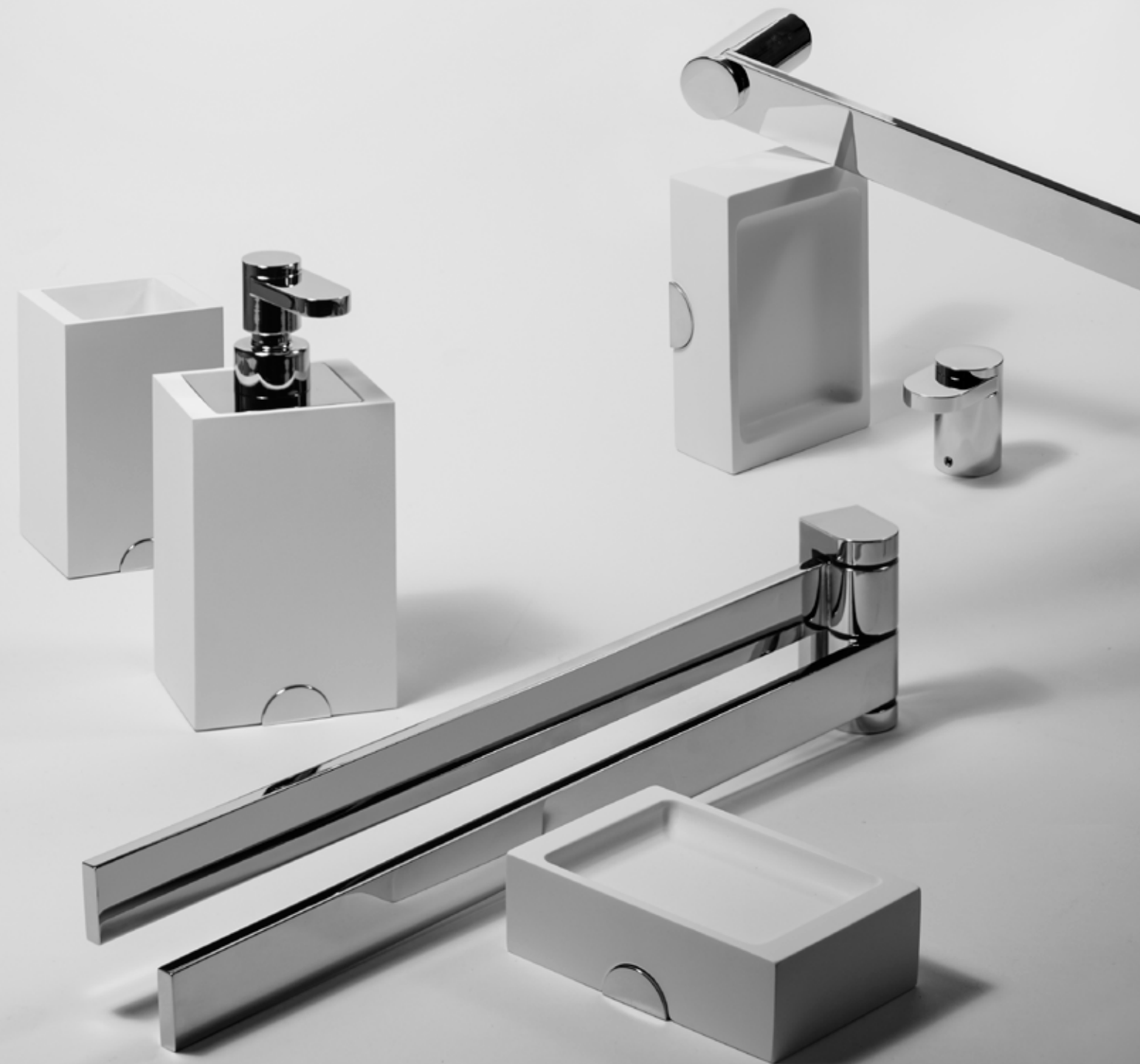



Cod. 5728

Per chi è alla ricerca di un design contemporaneo.

For those looking for a contemporary design.

Für alle, die ein zeitgemäßes Design suchen.

Pour ceux qui recherchent un design contemporain.

Para aquellos que buscan un diseño contemporáneo.

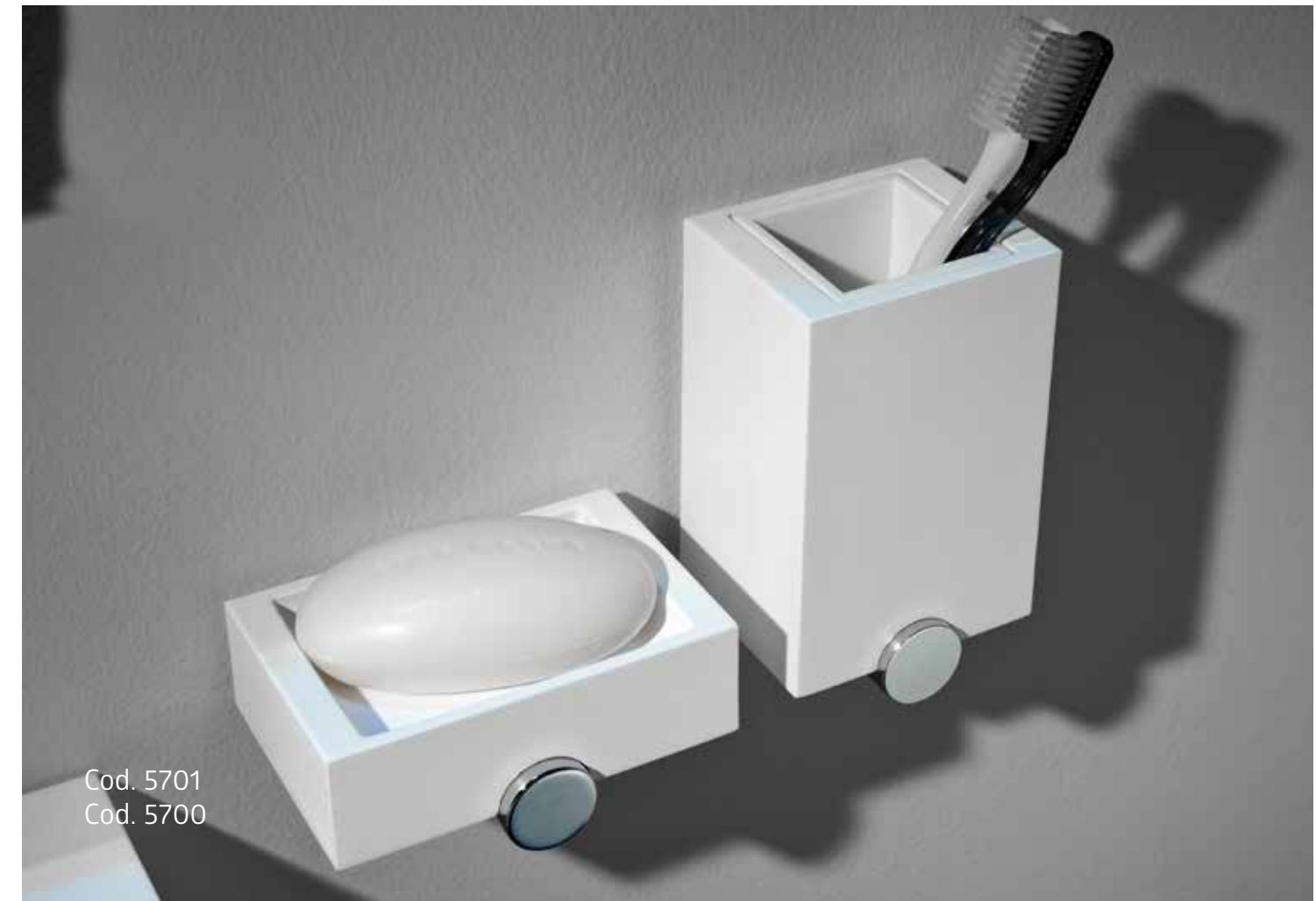

Cod. 5701
Cod. 5700



Cod. 5736
Cod. 5731



Cod. 5736



Cod. 5730
Cod. 5731



Cod. 5730
Cod. 5731

NEOLITECK:

è un materiale di nuova generazione composto in prevalenza da Titanio e Bauxite, coagulati da resine in poliestere. Grazie al suo aspetto di pietra levigata ed alla sua straordinaria resistenza e compattezza si presenta come un materiale piacevole alla vista e gradevole al tatto.

It is a new generation material composed mainly of Titanium and coagulated Bauxite and polyester resins. Thanks to its aspect of polished stone and to its extraordinary strength and compactness, it looks like an innovative material pleasing to the eye and to the touch.

Es ist ein Material der neuen Generation, das hauptsächlich aus Titan und Koaguliertern Bauxit und Polyesterharze besteht. Dank seiner Optik aus poliertem Stein und seiner außergewöhnlichen Stärke und Kompaktheit sieht es aus wie ein innovatives Material, das dem Auge und der Berührung gefällt.

Il est un matériau de nouvelle génération composé principalement de titane et de bauxite coagulées et de résines de polyester. Grâce à son aspect de pierre polie et à sa résistance et sa compacité extraordinaires, elle ressemble a un matériau innovant, agréable au regard et ou toucher.

Es un material de nueva generación compuesto principalmente de titanio y bauxita coagulada por resinas de poliéster. gracias a su aspecto de piedra pulida y su extraordinaria resistencia y compacidad, se presenta como un material agradable con un toque de tacto.



Cod. 5712



Cod. 5712
Cod. 5728

Polo è realizzato in 8 finiture:

Cromo
Bianco Mat
Nero Mat
Nichel Mat
Oro
Oro Mat
Oro Rosa
Bronzo



Cod. 5715

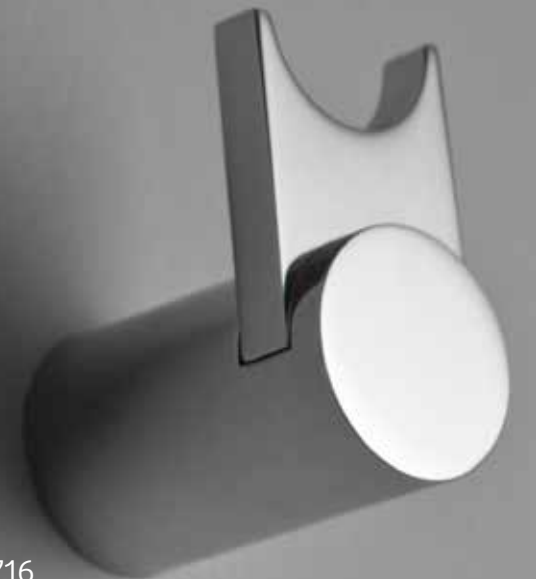

Cod. 5716



Cod. 5712

Polo is made in 8 finishes:

Chrome, white mat, black mat, nickel mat, gold mat, gold, rose gold, bronze

Polo ist in 8 Ausführungen hergestellt:

Chrom, Weiß matt, Schwarz matt, Nickel matt, Gold matt, Gold, Roségold, Bronze

Polo est fait en 8 finitions:

Chrome, blanc mat, noir mat, nickel mat, or mat, or, or rose, bronze

Polo está hecho en 8 acabados:

Cromo, blanco mate, negro mate, níquel mate, oro mate, oro, oro rosa, bronce





SCACCO

DESIGN OFFICINA BERTOCCI

UN CLASSICO CHE SARÁ SEMPRE
MODERNO.

A classic that will always be modern.
Ein Klassiker, der immer modern sein wird.
Un classique qui sera toujours modern.
Un clásico que siempre será moderno.



Forme rassicuranti di un classico che sarà sempre attuale.

Reassuring forms of a classic that will always be present.

Beruhigende Formen eines Klassikers, der immer präsent sein wird.

Formes rassurantes d'un classique qui sera toujours présent.

Formas tranquilizadoras de un clásico que siempre estará presente.



Cod. 1434



Cod. 1007



Cod. 1435

La classe di Scacco è storia.

The class of Scacco is history. - Die Klasse von Scacco ist Geschichte.

La classe de Sacco est histoire. - La clase Scacco es historia.





Inconfondibile, anche negli accessori più semplici.
Scacco a suo agio nel tuo bagno.

Unmistakeable even in the simplest accessories. Scacco is at ease in your bathroom
Unverkennbar, auch im einfachsten Zubehör. Es passt perfekt im Ihr Badezimmer auf.
Inconfondible, même dans les accessoires les plus simple. Scacco est confortable dans votre salle de bain.
Inconfundible incluso en los accesorios más simples. Alcance en su baño.

SCACCO

technical Info



Cod. 1002 + 1100 - (8,5 x h.9,5 x 13 cm.)



Cod. 1002 + 1101 - (h.3,5 x 12,5 ø cm.)



Cod. 1002 + 1128 - (h.16 x 9 ø cm.)



Cod. 1016 - (44 x h.5 x 7,5 cm.)
Cod. 1017 - (64 x h.5 x 7,5 cm.)



Cod. 1034 - (21 x h.22 x 23,5 cm.)



Cod. 1437 - (36 x h.17 x 38 cm.)



Cod. 1030 + 1100 - (?????????? cm.)



Cod. 1031 + 1101 - (?????????? cm.)



Cod. 1013 - (18 x h.5 x 8,5 cm.)



Cod. 1109 - (58,5 x h.8 x 36 cm.)



Cod. 1021 - (h.35 x 14 x 11 ø cm.)



Cod. 1022 - (h.41 x 8 ø cm.)



Cod. 1014 - (16 x h.14 x 8 cm.)



Cod. 1005 - (25 x h.12,5 x 8 cm.)



Cod. 1006 + 1101 - (25 x h.12,5 x 15 cm.)



Cod. 1390 - (h.66 x 21,5 cm.)



Cod. 1391 - (h.81 x 21,5 cm.)



Cod. 1393 - (h.92 x 26 cm.)



Cod. 1007 - (22 x h.5 x 14 cm.)



Cod. 1015 - (5 x h.6 x 7 cm.)



Cod. 1416 - (8 x h.5 x 6 cm.)



SETTECENTO

DESIGN OFFICINA BERTOCCI

MODERNISSIMA, SQUADRATA,
ESSENZIALE

Modern, square, essential
Modern, squarish, wesentlich
Moderne, carré, essentiel
Moderno, cuadrado, esencial





Cod. 743
Cod. 728
Cod. 750
Cod. 700
Cod. 736

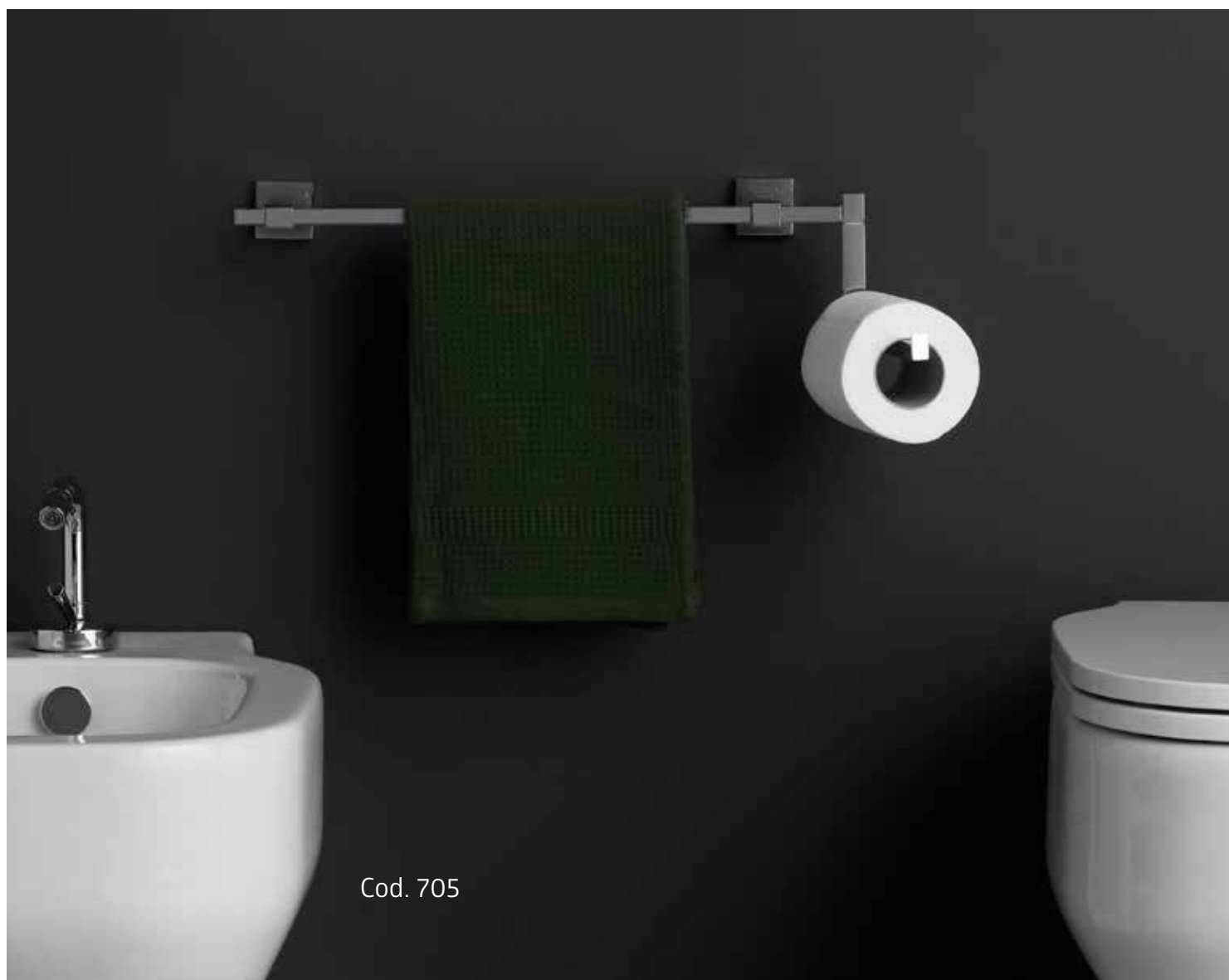

Cod. 705



Cod. 705

Unico articolo per piu' soluzioni

Same item for more solutions

Gleiche Artikel für mehrere Lösungen

Meme article pour plusieurs solutions

Artículo único para más soluciones

Forme rassicuranti di un classico che sarà sempre attuale.

Reassuring forms of a classic which will always be present.
Beruhigende Formen eines Klassikers das wird immer präsent sein.
Des formes rassurantes d'un classique qui sera toujours présent.
Formas tranquilizadoras de un clásico que siempre estará presente.



Cod. 743



Raffinati complementi in neoliteck

Refined elements in Neolyteck
Verfeinerte Elementen aus Neolyteck
Eléments raffinés en Neolyteck
Elementos refinados en Neolyteck



Utilizzo di foratura esistente

Tutti gli accessori della serie “Settecento” possono essere adattati per utilizzare i fori esistenti.

Exploitation of existing drilling

All “Settecento” accessories can be adapted to use existing holes.



Verwendung der vorhandenen Bohrgen

Alle Zubehöre der Serie “Settecento” Können angepasst werden, um vorhandene Löcher zu verwenden.

Utilizatio du percement existant

Tous les accessoires de la série “Settecento” peuvent être personnalisés pour utiliser les trous existants.

Uso de perforación existente

Todos los accesorios en la serie “Settecento” se puede adaptar para usar agujeros existentes.

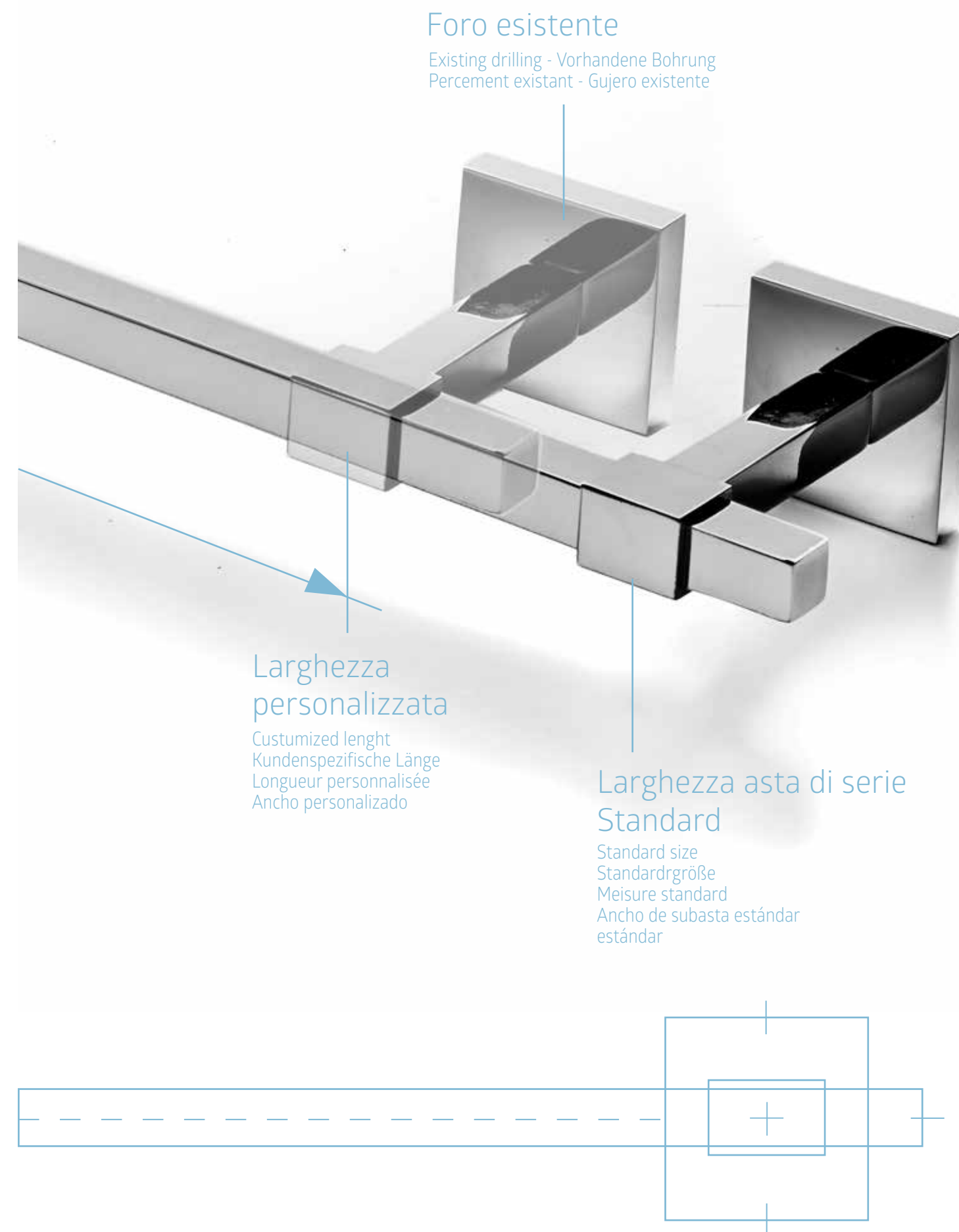

SETTECENTO

technical Info



Cod. 700 - (7 x h.12 x 8 cm.)



Cod. 701 - (10 x h.5 x 12 cm.)



Cod. 728 - (7 x h.18 x 8 cm.)



Cod. 716 - (35 x h.4 x 7,5 cm.)
Cod. 717 - (50 x h.4 x 7,5 cm.)
Cod. 718 - (65 x h.4 x 7,5 cm.)



Cod. 735 - (23 x h.21 cm.)



Cod. 736 - (37 x h.16 cm.)



Cod. 730 - (7 x h.12 x 7 cm.)



Cod. 731 - (10 x h.2 x 10 cm.)



Cod. 748 - (7 x h.18 x 7 cm.)



Cod. 775 - (4 x h.4 x 4 cm.)



Cod. 715 - (8 x h.7,5 x 4 cm.)



Cod. 703 - (17 x h.4 x 7,5 cm.)

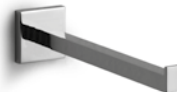

Cod. 733 - (4 x h.4 x 33 cm.)



Cod. 734 - (4 x h.4 x 133 cm.)



Cod. 714 - (9 x h.42 x 10 cm.)



Cod. 722 - (9 x h.42 x 9 cm.)



Cod. 743 - (34 x h.60 x 7,5 cm.)

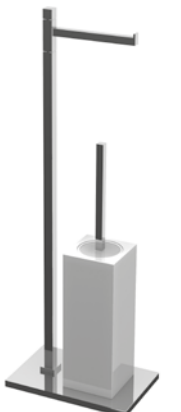

Cod. 758 - (12 x h.80 x 22 cm.)



Cod. 705 - (57 x h.15 x 7,5 cm.)



Cod. 706 - (57 x h.15 x 7,5 cm.)



Cod. 723 - (48 x 12 cm.)



Cod. 759 - (12 x h.84 x 22 cm.)



Cod. 760 - (18 x h.84 x 26cm.)



Cod. 750 - (65 x h.80 cm.)
 specchio reversibile con illuminazione LED



VELA

DESIGN OFFICINA BERTOCCI

UN DESIGN NUOVO, COME
PIEGATO DA UN SOFFIO.

A new design, like bent by a breath.

Ein neues Design, wie Geblutet von einem Atemzug.

Un nouveau design, comme Plié par un souffle.

Un nuevo diseño, como bent por un aliento.





Comp. 3433



Cod. 3415



Cod. 3403

VELA

technical Info



Cod. 3400 - (7 x h.12 x 9 cm.)
Cod. 3430 - (7 x h.12 x 9 cm.)



Cod. 3401 - (13 x h.4,5 x 9,5 cm.)
Cod. 3431 - (13 x h.4,5 x 9,5 cm.)



Cod. 3428 - (7 x h.16,5 x 9 cm.)
Cod. 3448 - (7 x h.16,5 x 9 cm.)



Cod. 3421 - (8,8 x h.42 x 11 cm.)
Cod. 3422 - (8,8 x h.42 x 11 cm.)



Cod. 3420 / 8420 - (h.66,5 x 15 x 12 ø cm.)

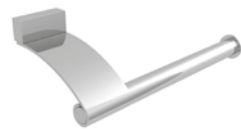

Cod. 3403 - (16,5 x h.5 x 7,5 cm.)

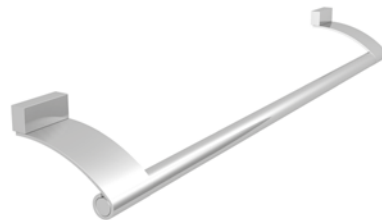

Cod. 3411 - (30 x h.5 x 7,5 cm.)
Cod. 3412 - (45 x h.5 x 7,5 cm.)
Cod. 3413 - (60 x h.5 x 7,5 cm.)

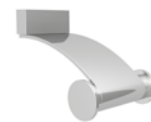

Cod. 3415 - (7 x h.5 x 7,5 cm.)



Cod. 3437 - (26 x h.19 cm.)
Cod. 3438 - (35 x h.19 cm.)

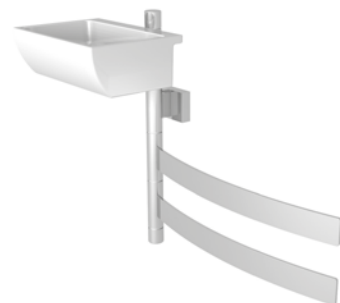

COMP. 3434 - (26 x h.24 cm.)



Cod. COMP. 3433 - (26 x h.28 cm.)



COMP. 3492 - (14 x h.82 x 24 cm.)



Cod. 3493 - (18 x h.84,5 x 29,5 cm.)



KIT QUADROTTO

DESIGN OFFICINA BERTOCCI

LA TUA SERIE QUADRATA TUTTA IN UNA SCATOLA

Your square collection everything inside a box
Deine Square Serie in einer Box
Votre série carrée tout en un boîte
Su serie cuadrada todo en una caja





KIT FILOTTO

DESIGN OFFICINA BERTOCCI

LA TUA SERIE ROTONDA TUTTA IN UNA SCATOLA

Your round collection everyting inside a box
Deine runde Serie in einer Box
Votre série ronde tout en un boîte
Su serie ronda todo en una caja





COMPLEMENTI DOCCIA

DESIGN OFFICINA BERTOCCI



COMPLEMENTI DOCCIA

technical Info



Cod. 127 - (18 x h.120 x 10 cm.)



Cod. 126 - (18 x h.80 x 10 cm.)



Cod. 160 - (22 x h.25 x 20 cm.)



Cod. 161 - (20 x h.25 x 20 cm.)



Cod. 162 - (20 x h.50 x 20 cm.)



Cod. 163 - (26,5 x h.7 x 26,5 cm.)



Cod. 176 - (22 x h.11,5 x 22 cm.)

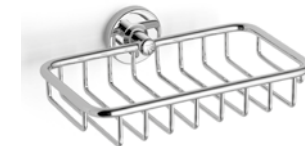

Cod. 572 - (22 x h. 3 x 12 cm.)



Cod. 2072 - (36 x h.2,5 x 10 cm.)



Cod. 164 - (26 x h.8,5 x 12 cm.)
Cod. 165 - (40 x h.8,5 x 12 cm.)



Cod. 524 - (18 x h.22 x 18 cm.)



Cod. 1007 - (22 x h.5 x 14 cm.)



Cod. 7030 - (17 x h.7,5 x 17 cm.)

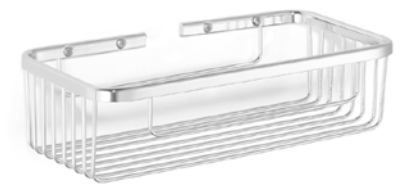

Cod. 170 - (26 x h.7 x 13,5 cm.)



Cod. 525 - (18 x h.22 x 18 cm.)

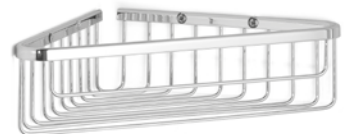

Cod. 7031 - (22,5 x h.7,5 x 22,5 cm.)

BERTOCCI

Bathroom Accessories

Bertocci Industrie s.r.l.

Sede Legale : Via A. La Marmora, 39 - Firenze
Sede Operativa e Amministrativa : Via L.Fontana, 7
50028 - Sambuca Val di Pesa (FI)
Tel. : +39 055 809 1930 Fax : +39 055 8091014

Email: info@bertocci.it

Febbraio 2018

Le immagini e i dati contenuti nel presente catalogo sono da ritenersi indicativi
E possono subire variazioni anche senza alcun preavviso.

The images and information of the current catalogue should be taken just as indications
and could be submitted to changes without any given notice.

Die in diesem katalog angeführten abbildungen und daten
Sind richtwerte und können auch ohne vorankündigung geändert werden.

Les images et les informations contenus dans le present catalogue sont a considerer indica-
tifs et sont susceptibles de modifications a tout moment et sans preavis.

Las imagenes y los datos contenidos en el presente catálogo se deben considerar como
indicativos y pueden sufrir variaciones tambien sin ningun preaviso.

BERTOCCI
Bathroom Accessories